



United Pacific

# TRUCK

2019 *New Product Collection*



### HOW TO ORDER

To order from United Pacific Industries, you must be an authorized dealer, distributor or OEM. If you are not authorized to stock and sell United Pacific products, you must order through an authorized dealer. Please call 800.790.6988 for more information.

### CONTACT US

-  8 am - 4:30 pm PST
-  800.790.6988 / 562.421.3888
-  888.986.5988
-  [Sales@upauto.com](mailto:Sales@upauto.com)
-  [UPauto.com](http://UPauto.com)
-  3788 E. Conant St., Long Beach, CA 90808

### QUALITY

With over 30 years of experience in the automotive aftermarket industry, United Pacific Industries understands the rigors and stresses that our products are subjected to on the road. It is our mission to provide our customers with products of superior quality and reliability. In achieving this goal, United Pacific only partners with manufacturing facilities that conforms to our quality control requirements and standards. Our manufacturing partners meet or exceed ISO-9001 requirements. In addition, United Pacific's manufacturing partners must be equipped on site to perform the following quality assurance tests and maintain a track record of consistent quality and low product failure rate.

- Photometric Test
- Pull Force Test
- Rain Test
- Salt Spray Test
- Shock Test
- Temperature Test
- Humidity Test
- Vibration Test

Furthermore, our internal quality control structure allows us to function as the final quality control station prior to shipping. With the assistance of 3D computer technology, United Pacific can adhere to strict quality control standards during prototype creation and the production process. Our engineers and technicians perform a battery of tests to ensure that our products meet the demands of today's drivers and our goal to be first in quality.

### INNOVATION

Known as the leader in innovation, United Pacific is dedicated to be the first to bring new and exciting products to the market. United Pacific's global expertise allows us to search the globe for new ideas and concepts. Not only do we search the globe for new products, United Pacific invest a significant amount of resources into our own research and development efforts. With the assistance of advance 3D scanning technology, our engineers and designers can acquire accurate and precise data in seconds. The 3D data allows United Pacific to verify designs, perform quality assurance tests, and reverse engineer with unprecedented speed and accuracy. Digital inspection contributes to the early detection of shape problems, provides rapid feedback on design, and eliminates unnecessary work in downstream processes. Our rapid prototyping facility permits us to have a concept-to-shelf time of less than 5 months. In addition, United Pacific's 3D printing capabilities permit our designers to have physical models of their design concepts in hours. The physical models allow our designers and marketing staff to evaluate and test the viability of different design ideas. Our rapid prototyping facility allow United Pacific to compress design cycles, improve manufacturing planning, shorten concept-to-shelf time, most importantly, generate new and innovative products.

### DESIGN

Located near some of the nation's most progressive automotive design centers, United Pacific established the UP Design Studio in 2002 to consolidate our position as the design leader in the automotive industry. UP Design Studio utilizes the latest generation of computer aided design (CAD) and studio/graphic software. The design studio is equipped with the newest computers and rapid prototyping systems. In addition, UP Design Studio is staffed by graduates from the nation's most prestigious design colleges. Unlike our competitors, United Pacific's design and manufacturing capabilities mean that we carry more new and original items than our competitors. The establishment of the design studio will enable us to generate even more new products with significant shorter concept-to-shelf time. The reduction in development cost mean that we can develop products utilizing design based development processes. Design based product development allows United Pacific to create new product concepts based on designs incorporating driver demands and needs instead of economic considerations. United Pacific's emphasis on design distinguishes and positions us ahead of our competitors.



## WARRANTY

With LED (Light Emitting Diodes) rated at 100,000 hours of operation and solid-state construction, United Pacific's LED lights are extremely reliable and durable. Purchase with confidence, United Pacific offers a complete line of LED lighting products with extended or limited lifetime warranties. Please see the warranty policy page for more details.

## INVENTORY AND SHIPPING

United Pacific carries over 20,000 items in our California distribution center. No other company in the heavy duty trucking industry can match United Pacific in the variety and range of in-stock inventories. With an order fill rate of over 98.5%, United Pacific is the largest and most reliable supplier in the industry. Our shipping department ships 96.8% of all orders within 24 hours and 98.9% within 48 hours. United Pacific's vast inventory and prompt shipping has made United Pacific the only source for our customer's chrome and lighting needs.



## HARD AT WORK FOR THE ENVIRONMENT



**United Pacific**  
**132,000** sq ft  
**Distribution Center**  
**Long Beach, CA**

- 100%** reduction in potable water used for landscaping
- 40%** reduction in total energy use due to high-efficiency mechanical and lighting systems
- 82%** of construction waste was diverted from landfills

## LEED ACCOMPLISHMENTS

### Sustainable Sites

- On-site bicycle storage, showers and changing areas for company employees.
- Preferred parking for low-emitting, fuel-efficient and carpool vehicles.
- Stormwater is infiltrated on-site and treated to remove contaminants to reduce environmental impact on local waterways.

### Water Efficiency

- In addition to using reclaimed water, drought-tolerant plants and a high-efficiency irrigation system were installed to reduce the use of potable water for irrigation by 100%.

### Energy and Atmosphere

- Efficient HVAC equipment and a lighting system with daylight controls reduces energy consumption by over 30%.
- Enhanced commission verifies that the building's energy and water-related systems are performing as intended by the initial design.

### Indoor Environmental Quality

- Building ventilation systems was designed to provide enhanced levels of fresh outside air to building occupants.
- Interior finishes (plants, sealants, adhesives, coatings, carpet systems and composite wood) were selected with low levels of volatile organic compounds (VOCs) to reduce indoor air contamination.



# NEW ITEMS

January 2019

## Headlight Assembly for Freightliner Cascadia, Accessories for Freightliner, Kenworth, Isuzu, and more...

### Cascadia Headlight

**100%LED**

**DOT & SAE APPROVED**



### High Power LED Headlight with LED Daytime Running Light & LED Turn Signal for 2008 - 2017 Freightliner Cascadia

- High power LED headlight with 57 LED DRL & 55 LED turn signal
- Dual color LED position light bar changes from white to amber when turn signal activated
- Easy connection, plug & play design, plugs into existing headlight wiring harness
- DOT/SAE headlight approved
- Sold individually, please specify driver or passenger side
- **1 year warranty**



| Technical Specification |                       |
|-------------------------|-----------------------|
| Low Beam Application    | High Beam Application |
| 1000 Lumens             | 2000 Lumens           |
| 2.2 Amps                | 4.4 Amps              |
| 12V DC Input            | 12V DC Input          |

|              |          |                                      |
|--------------|----------|--------------------------------------|
| <b>35790</b> | Chrome   | <b>Driver</b> - 1 Pc. / Color Box    |
| <b>35791</b> | Chrome   | <b>Passenger</b> - 1 Pc. / Color Box |
| <b>35792</b> | Blackout | <b>Driver</b> - 1 Pc. / Color Box    |
| <b>35793</b> | Blackout | <b>Passenger</b> - 1 Pc. / Color Box |



### LED Work Light



**COMPETITION SERIES** **1000 Lumens** **12v/24v** **IP68 WATERPROOF**

#### 5 LED High Power Mini Round Work Light

- 5 high power LED lights with spot or flood function for powerful performance
- IP68 waterproof with die cast housing and sealed polycarbonate lens provide maximum protection & durability
- Solid state design resists shock and vibration

|              |                                  |
|--------------|----------------------------------|
| <b>36461</b> | <b>Flood</b> - 1 Pc. / Color Box |
| <b>36463</b> | <b>Spot</b> - 1 Pc. / Color Box  |



**COMPETITION SERIES** **1000 Lumens** **12v/24v** **IP68 WATERPROOF**

#### 5 LED High Power Mini Square Work Light

- 5 high power LED lights with spot or flood function for powerful performance
- IP68 waterproof with die cast housing and sealed polycarbonate lens provide maximum protection & durability
- Solid state design resists shock and vibration

|              |                                  |
|--------------|----------------------------------|
| <b>36462</b> | <b>Flood</b> - 1 Pc. / Color Box |
| <b>36464</b> | <b>Spot</b> - 1 Pc. / Color Box  |



### Magnetic Rechargeable LED Work Light

- High power portable LED flood light with polycarbonate lens
- 3 brightness options: 30% / 70% / 100%
- 3 flashing options: Fast / Slow / S.O.S.
- Solid state design resists shock and vibration
- The ultra-strong magnetic base holds the light to most metallic surfaces
- USB port for recharging cell phones
- Rechargeable lithium battery provides 4 hours of run time

**36624** 1 Pc. / Color Box

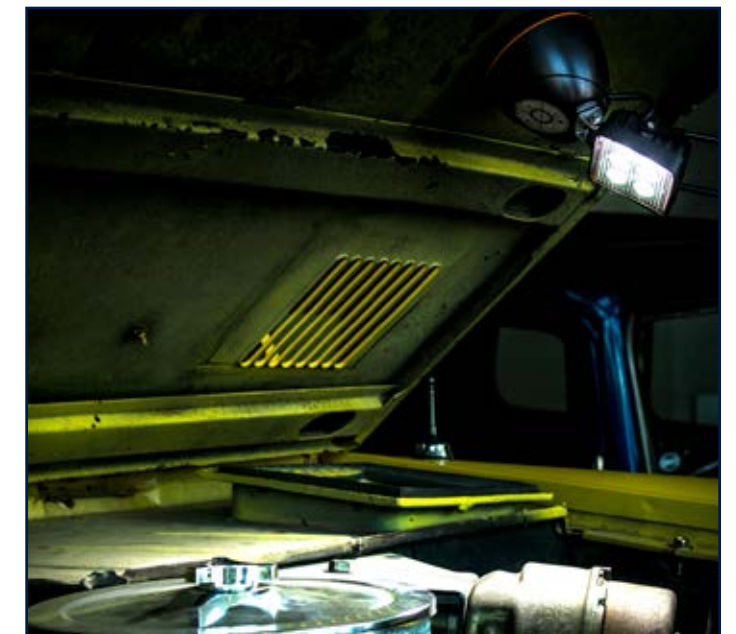

USB port / 1 amp max

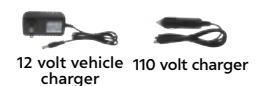

12 volt vehicle 110 volt charger

**For Isuzu NPR**



**Black Steel Front Panel Assembly for Isuzu NPR (ELF 400/500/600)**

- Quality 22 gauge stamped steel
- Finish with black EDP protective coating
- OEM number: 8-98122-695-0

**21627** 1 Pc. / Box



**Flat Type Corner Panel for Isuzu NPR (ELF 400/500/600)**

- Quality injection mold white ABS plastic
- Mounting clips and liners included for easy installation
- OEM number: 8-98036-525-5 (driver) / 8-98036-524-5 (passenger)

**21628** Driver - 1 Pc. / Box

**21629** Passenger - 1 Pc. / Box

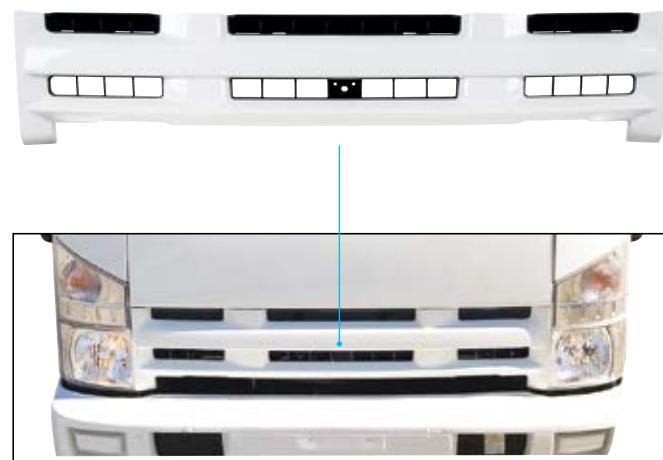

**White Grille for Isuzu NPR (ELF 400/500/600)**

- White painted ABS plastic with black grille opening accent
- Mounting clips pre-installed for easy installation
- OEM number: 8-98025-468-4

**21650** 1 Pc. / Box



**Step Panel with Reflector & Mud Flap for Isuzu NPR (ELF 400/500/600)**

- High quality black ABS plastic
- Amber sidemarker lens included with mounting clips
- Also includes 2 black push-in mounting plugs with foam pad
- OEM number: 8-98022-775-3 (driver) / 8-98022-774-3 (passenger)

**21742** Driver - 1 Pc. / Bulk

**21743** Passenger - 1 Pc. / Bulk

**For Freightliner Columbia**



**Chrome Center Bumper for 2002 - 2012 Freightliner Columbia**

- Heavy duty chrome center bumper for Freightliner Columbia
- Available with tow hole

**21098** 1 Pc. / Box



**Flame Shift Knob**

- Ultra high quality finish, available in chrome or matte black
- Heavy duty construction ensures strength and durability
- Easy set screw installation
- Installation hardware included

**70748** Chrome - 1 Pc. / Card

**70749** Chrome/Black - 1 Pc. / Card

**Universal Product**



**15/16" Top Chrome Gearshift Mounting Adaptor for Eaton-Fuller 13/15/18 Speed Shifters**

- Chrome diecast gearshift mounting adaptor for United Pacific CNC gear shift knobs
- New self-centering o-ring design, o-ring provided for a tighter fit and reduces vibration
- Fits 13/15/18 Speed Gearshift Knobs

**70604B** 1 Pc. / Bulk



**Flame 13/15/18 Speed Shift Knob**

- Fits 13/15/18 gearshift knobs
- Ultra high quality finish, available in chrome or matte black
- Heavy duty construction ensures strength and durability
- Easy set screw installation
- Installation hardware included
- Mounting adaptor: item number 70603B and flame shift knob: item number 70748 (chrome) / 70749 (black) available separately

**70574** Chrome - 1 Pc. / Card

**70575** Chrome/Black - 1 Pc. / Card

## 430 STAINLESS STEEL HOUSING

Why settle for aluminum when you can have stainless steel?



90050



90054



90055

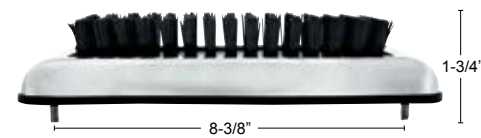
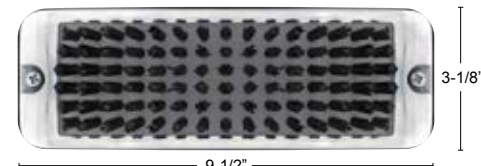

### Stainless Steel Shoe/Boot Scraper

- Shoe/boot scraper with 430 stainless steel housing
- Mounts to exterior steps, mounting screws are approximately 8 3/8" apart
- Includes mounting gasket and mounting hardware

|              |  |
|--------------|--|
| <b>90050</b> | <b>Black</b> - 1 Pc. / Color Box             |
| <b>90054</b> | <b>Blue</b> - 1 Pc. / Color Box <b>(NEW)</b> |
| <b>90055</b> | <b>Red</b> - 1 Pc. / Color Box <b>(NEW)</b>  |

### Merchandising



### United Pacific Truck Banner

- Banner for United Pacific truck parts and accessories
- Dimension approximately = 47" w x 35" L

**99100** 1 Pc. / Bulk



**COMPETITION SERIES**

### Chrome 40" Heavy Duty Swivel Stick

- Heavy duty chrome swivel stick pipe with hose or cable holder
- 40 7/8" Length Pipe and 7/8" Diameter

**94010** 1 Pc. / Box



### United Pacific Steering Wheel Display - Type I

- Includes United Pacific steering wheel: item number 88217/88177
- Includes United Pacific chrome hub/horn button: item number 88216/88120/88261

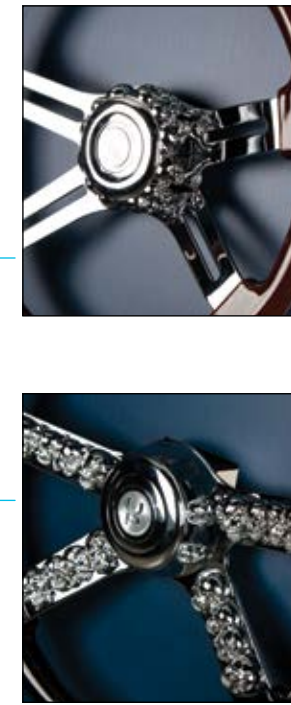

| INCLUDES           |       |
|--------------------|-------|
| <b>Wheel</b>       |       |
|                    |       |
| 88217              | 88177 |
| <b>Hub</b>         |       |
|                    |       |
| 88216              | 88261 |
| <b>Horn Button</b> |       |
|                    |       |
| 88120              |       |

**99131** 1 Set / Box



### United Pacific Steering Wheel Display - Type II

- Includes United Pacific steering wheel: item number 88217/88215
- Includes United Pacific chrome hub/horn button: item number 88223/88120/88261

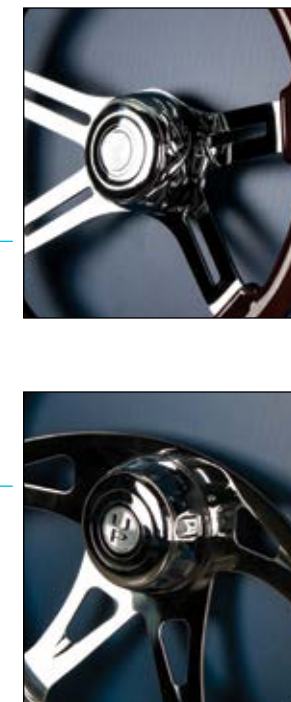

| INCLUDES           |       |
|--------------------|-------|
| <b>Wheel</b>       |       |
|                    |       |
| 88217              | 88215 |
| <b>Hub</b>         |       |
|                    |       |
| 88223              | 88261 |
| <b>Horn Button</b> |       |
|                    |       |
| 88120              |       |

**99132** 1 Set / Box

# NEW ITEMS

February 2019

Headlight Assembly for Peterbilt 388/389, Mirror Assembly for Volvo VNL, and more...

## Peterbilt Headlight

**100%LED**

DOT & SAE APPROVED

Patent Pending Unique Lens Design

Dual Color LED Position Light Bar



White LED position light bar changes to amber when turn signal is activated

## High Power LED Headlight with LED Position Light & LED Turn Signal for 2008+ Peterbilt 388/389

- High power LED headlight with 57 LED position light and 16 LED turn signal
- Bold and unique headlight design. Patent pending design
- Headlight assembly for Peterbilt 388/389 trucks
- Dual color LED position light bar changes from white to amber when turn signal activated
- Patent pending unique lens design
- Easy connection, plugs into existing wiring harness
- DOT/SAE headlight approved
- Sold individually, please specify driver or passenger side
- **3 years warranty**



### Technical Specification

| Low Beam Application | High Beam Application |
|----------------------|-----------------------|
| 1600 Lumens          | 2400 Lumens           |
| 1.25 Amps            | 1.25 Amps             |
| 12V DC Input         | 12V DC Input          |

|              |          |                                      |
|--------------|----------|--------------------------------------|
| <b>31146</b> | Blackout | <b>Driver</b> - 1 Pc. / Color Box    |
| <b>31147</b> | Blackout | <b>Passenger</b> - 1 Pc. / Color Box |

## Universal Products

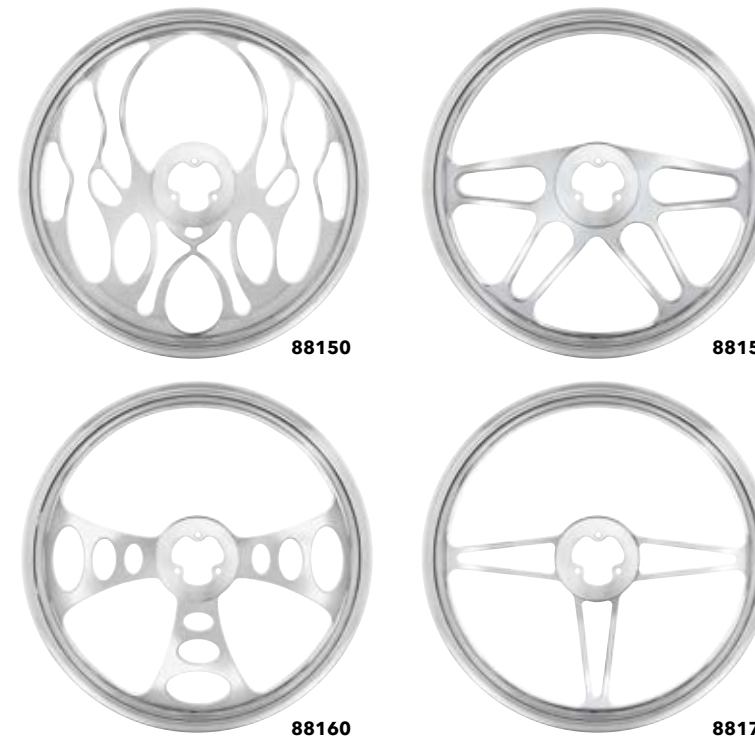

3 hole bolt patterns fits existing steering wheel hubs. No need for special 3-5 hub adaptor



Includes special extended screws for installation



## Chrome Aluminum 18" Steering Wheel

- Chrome aluminum steering wheel rim
- High quality CNC aluminum with chrome plating
- Steering wheel only. Hub and horn button assembly available separately
- Mix and match with United Pacific hubs and designer horn bezels for a unique and distinctive look

|              |                                    |              |
|--------------|------------------------------------|--------------|
| <b>88150</b> | <b>Blaze</b> - 1 Pc. / Color Box   | <b>(NEW)</b> |
| <b>88154</b> | <b>4-Spoke</b> - 1 Pc. / Color Box | <b>(NEW)</b> |
| <b>88160</b> | <b>Chopper</b> - 1 Pc. / Color Box | <b>(NEW)</b> |
| <b>88171</b> | <b>3-Spoke</b> - 1 Pc. / Color Box |              |



## 18" Wood Steering Wheel

- 18" wood rim steering wheel with chrome spoke
- Steering wheel only, hub and horn assembly available separately
- Mix and match with United Pacific hub and designer horn bezel for a unique and distinctive look

|              |                                      |
|--------------|--------------------------------------|
| <b>88103</b> | <b>Hourglass</b> - 1 Pc. / Color Box |
| <b>88104</b> | <b>Inferno</b> - 1 Pc. / Color Box   |
| <b>88105</b> | <b>Firestorm</b> - 1 Pc. / Color Box |
| <b>88106</b> | <b>Banjo</b> - 1 Pc. / Color Box     |
| <b>88107</b> | <b>Scorpion</b> - 1 Pc. / Color Box  |

**For Freightliner Cascadia**

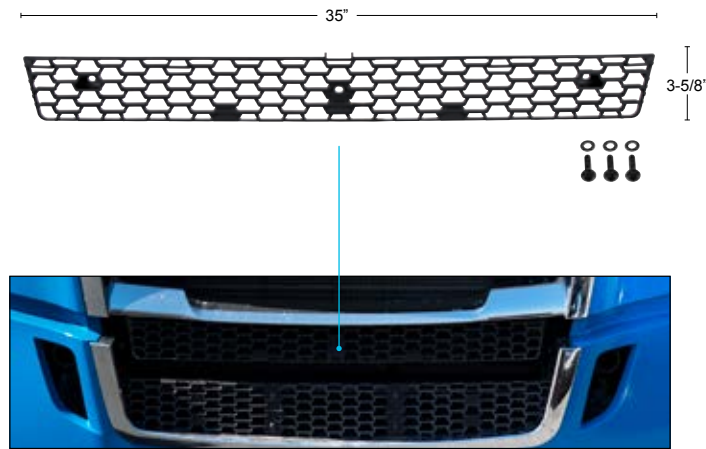

**Lower Grille for 2018+ Freightliner Cascadia**

- Lower mesh grille insert
- Replace OEM number: A17-20845-000
- Mounting hardware included

**42484** 1 Pc. / Box



**Inner Air Dam Bumper Carrier for 2018+ Freightliner Cascadia**

- Replace OEM number: 21-28992-000 (item # 42480) / 21-28992-001 (item # 42481)
- Mounting hardware included
- Sold Individually, Please specify driver or passenger side

**42480** **Driver** - 1 Pc. / Box  
**42481** **Passenger** - 1 Pc. / Box

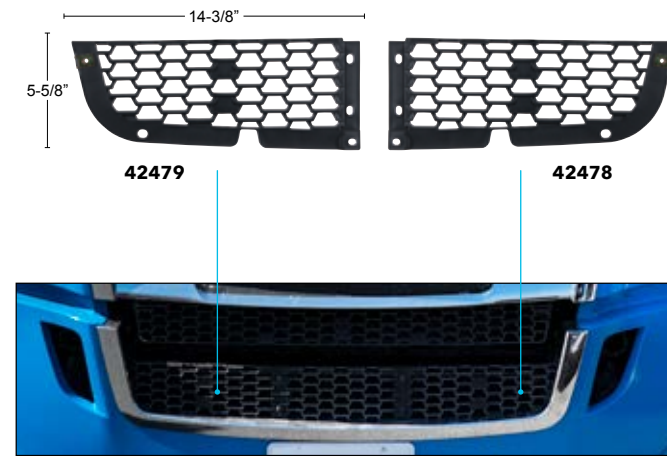

**Bumper Mesh for 2018+ Freightliner Cascadia**

- Mesh grille insert
- Replace OEM number: 21-28985-000 (item # 42478) / 21-28985-001 (item # 42479)
- Sold Individually, Please specify driver or passenger side

**42478** **Driver** - 1 Pc. / Box  
**42479** **Passenger** - 1 Pc. / Box



**Outer Air Dam Bumper Carrier for 2018+ Freightliner Cascadia**

- Replace OEM number: 21-28990-000 (item # 42482) / 21-28990-001 (item # 42483)
- Mounting hardware included
- Sold Individually, Please specify driver or passenger side

**42482** **Driver** - 1 Pc. / Box  
**42483** **Passenger** - 1 Pc. / Box

**For Volvo VNL**



**Mirror Assembly for 2004 - 2012 Volvo VNL - Heated**

- Includes complete mirror and mounting arm with chrome or black cover, includes CB antenna mount
- Has Power Adjustable Mirror with Heat, LED Turn Signal & Antenna
- Replace OEM number: 82239803 (item # 42830) / 82239804 (item # 42831)
- Sold Individually, Please specify driver or passenger side

**42830** Black **Driver** - 1 Pc. / Box  
**42831** Black **Passenger** - 1 Pc. / Box  
**42832** Chrome **Driver** - 1 Pc. / Box  
**42833** Chrome **Passenger** - 1 Pc. / Box



**Auxiliary Convex Mirror with LED Turn Signal for 2012 - 2018 Volvo VNL - Heated**

- Helps improve visibility, available with LED signal lens
- Replace OEM number: 85108729 (item # 42835) / 85108728 (item # 42836)
- Sold Individually, Please specify driver or passenger side

**42835** **Driver** - 1 Pc. / Box  
**42836** **Passenger** - 1 Pc. / Box



**Auxiliary Convex Mirror for 2004 - 2012 Volvo VNL - Heated**

- Helps improve visibility
- Replace OEM number: 85112491

**42834** 1 Pc. / Box



**Main Exterior Mirror for 2004 - 2018 Volvo VNL - Heated**

- Helps improve visibility
- Replace OEM number: 85114948

**42837** 1 Pc. / Box



**For Peterbilt**



**Stainless 7" Chopped Window Trim for Peterbilt Trucks**

- Fits 2005+ Peterbilt 379, 386, 389 trucks and various other Peterbilt models with cab mounted mirrors
- Polished 304 stainless steel
- Easy to install pressure sensitive adhesive mounting
- Includes 1 piece lefthand trim, 1 piece righthand trim

**29096** 1 Pair / Color Box

**Universal Products**



**Stainless 30" Spring Loaded Mud Flap Hanger with Conspicuity Reflector - 2 1/2" Bolt Pattern**

- 30" Heavy Duty Spring Loaded Mud Flap Hanger
- 430 Stainless Steel
- Open end cap / 2 1/2" bolt center
- Stainless Steel End Plug Available Separately: Item number: 20611

**10849** 1 Pair / Color Box

**NEW & IMPROVED**



**Chrome 1" Top Gearshift Mounting Adaptor for Eaton-Fuller 13/15/18 Speed Shifters**

- Chrome diecast gearshift mounting adapter for United Pacific CNC gear shift knobs
- New self-centering o-ring design, o-ring provided for a tighter fit and reduces vibration
- Fits all Eaton-Fuller 13/15/18 speed shifters

**70664B** 1 Pc. / Bulk

**NEW PACKAGING**



**13/15/18 Gearshift Knob with Adaptor**

- Fits 13/15/18 speed gearshift knobs
- Mounting adapter: item number 70603B available separately
- T-Grip Mounting adapter: item number 70604B available separately

|              |   |
|--------------|---|
| <b>70611</b> | <b>Chrome Skull Head</b> - 1 Pc. / Card |
| <b>70654</b> | <b>Chrome Dice</b> - 1 Pc. / Card       |
| <b>70615</b> | <b>Red Dice</b> - 1 Pc. / Card          |
| <b>70642</b> | <b>Chrome Skull</b> - 1 Pc. / Card      |
| <b>70669</b> | <b>Black Skull</b> - 1 Pc. / Card       |
| <b>70692</b> | <b>T-Grip</b> - 1 Pc. / Card            |



**COMPETITION SERIES**

**24" x 24" Heavy Duty Black Poly Quarter Fender Set**

- Black polymer material is chip, dent, and scuff resistant
- Internal bracket mounting system eliminates u-bolts and other external hardware
- Tube bracket & clamp, top mud flap, and mounting hardware included
- Frame mounting post sold separately

**10714** 1 Pair / Box

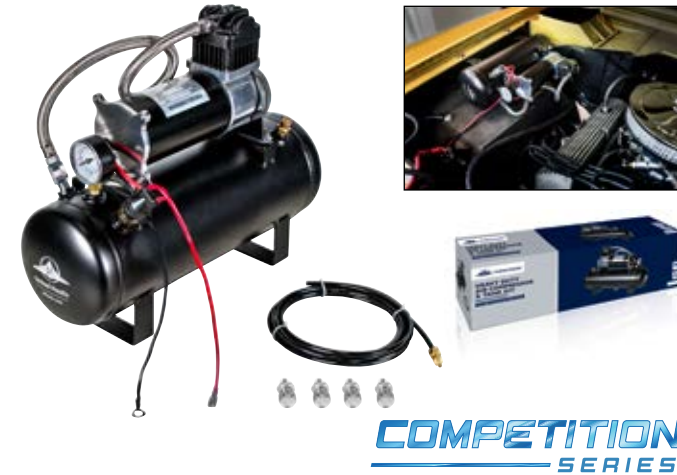

**Heavy Duty 12V 140 PSI Air Compressor & Tank Kit**

- Heavy duty air compressor and tank system
- 140 psi for air horns, general on-board air applications & off-road use
- High volume reciprocating compressor with 1.5 gallon tank permits extended air horn operation
- Automatic on/off pressure switch
- Compressor & tank can be stacked together, or mounted separately to accommodate different mounting locations
- External screw thread hose connector: 1/4NPT & 1/8NPT
- Hose size: O.D. 1/4"
- Sold in set, includes 1 air compressor and 1 air tank
- Kit includes: 12 volt air compressor, steel air tank with safety valve, air pressure gauge, air hose and connector fittings to attach most air horns and mounting hardware & instructions

**46154** 1 Set / Color Box

**NEW & IMPROVED**



**U.S. Military Adhesive Metal Medallion - 1 3/4"**

- 1 3/4" round U.S. military adhesive metal medallion
- Minted in a brass alloy and finished in bronze
- Officially licensed product

|              |                                 |
|--------------|---------------------------------|
| <b>22974</b> | <b>Air Force</b> - 1 Pc. / Bulk |
| <b>22975</b> | <b>Army</b> - 1 Pc. / Bulk      |
| <b>22976</b> | <b>Navy</b> - 1 Pc. / Bulk      |
| <b>22977</b> | <b>Marine</b> - 1 Pc. / Bulk    |

**NEW & IMPROVED**



**Chrome Deluxe Large U.S. Military Medallion Dash Knob**

- Large chrome aluminum deluxe dash knob with U.S. military metal medallion
- Hex screw mount

|              |                                 |
|--------------|---------------------------------|
| <b>22960</b> | <b>Air Force</b> - 1 Pc. / Bulk |
| <b>22961</b> | <b>Army</b> - 1 Pc. / Bulk      |
| <b>22962</b> | <b>Navy</b> - 1 Pc. / Bulk      |
| <b>22963</b> | <b>Marine</b> - 1 Pc. / Bulk    |

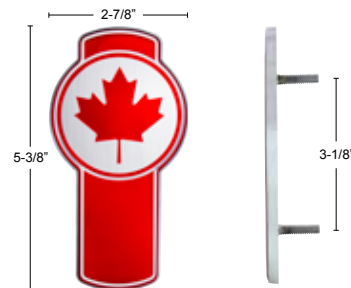

### Flag Emblem

- Universal application
- Chrome emblem - 5 3/8" x 2 7/8", Mounting studs are 3 1/8" apart

|              |   |
|--------------|---|
| <b>10978</b> | <b>Canada</b> - 1 Pc. / Card <b>(NEW)</b> |
| <b>10965</b> | <b>Texas</b> - 1 Pc. / Card               |
| <b>10966</b> | <b>U.S.A.</b> - 1 Pc. / Card              |
| <b>10967</b> | <b>Mexico</b> - 1 Pc. / Card              |

### NEW & IMPROVED

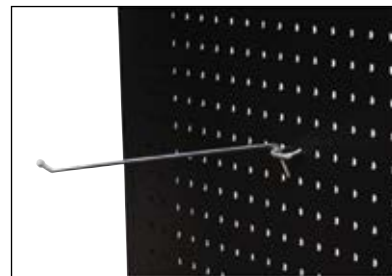

### 8" L Peg Hook for United Pacific Store Display

- 8" L peg hook for United Pacific store display
- 8" L x 0.212" Dia

**99000** 1 Pc. / Bulk

### 10 Quarts Capacity



### Da CoolBox

#### 10qt Da Coolbox Thermoelectric Cooler/Warmer

- Cools without ice, making more space for food and drinks
- Great for travel to keep your contents fresh and dry
- Shoulder strap for easy transportation
- USB charging port for mobile devices
- Selector switch for cool/heat
- 10 liter storage volume
- Dual Power Supply: 12V DC, 110V AC
- Solid, strong exterior for added durability

**99121** 1 Pc. / Color Box

### 23 Quarts Capacity



### Da CoolBox

#### 23qt Da Coolbox Thermoelectric Cooler/Warmer

- Cools without ice, making more space for food and drinks
- Great for travel to keep your contents fresh and dry
- Shoulder strap for easy transportation
- USB charging port for mobile devices
- Digital LCD display and temperature adjustment control
- 22 liter storage volume
- Dual Power Supply: 12V DC, 110V AC
- Solid, strong exterior for added durability

**99122** 1 Pc. / Color Box

# NEW ITEMS

March 2019

### Headlight Assembly for Peterbilt 382/384/386/387, LED Fog Light for Volvo VN/VNL, and more...

#### Peterbilt Headlight

**DOT & SAE APPROVED**

**Dual Color LED Position Light Bar**



Dual color LED DRL/position light bar changes from white to amber when turn signal is activated



#### Projection Headlight with LED Position Light & LED Turn Signal for 2008+ Peterbilt 382/384/386/387

- Peterbilt 382/384/386/387 projection headlight with LED light bar & turn signal
- 6 amber LED turn lights
- Easy connection, plugs into existing harness
- Back cover included
- DOT/SAE headlight approved
- Sold individually, please specify driver or passenger side
- **3 year warranty**



#### Technical Specification

| Low Beam Application | High Beam Application |
|----------------------|-----------------------|
| H11 55 Watt          | HB3 60 Watt           |
| 4.5 Amps             | 5 Amps                |
| 12.8V DC Input       | 12.8V DC Input        |

|              |          |                                      |
|--------------|----------|--------------------------------------|
| <b>35808</b> | Chrome   | <b>Driver</b> - 1 Pc. / Color Box    |
| <b>35809</b> | Chrome   | <b>Passenger</b> - 1 Pc. / Color Box |
| <b>35810</b> | Blackout | <b>Driver</b> - 1 Pc. / Color Box    |
| <b>35811</b> | Blackout | <b>Passenger</b> - 1 Pc. / Color Box |





**DOT & SAE APPROVED** **100% LED** **1400 Lumens** **12v/24v**

### High Power LED Fog Light with LED Daytime Running Light & LED Position Light for 2003 - 2017 Volvo VN/VNL

- LED fog light and daytime running light with LED position light
- Bold and unique design
- Easy connection, plugs into existing wiring harness
- Position light can be wired independently (extra wiring required)
- Dot/SAE approved
- Sold individually, please specify driver or passenger side

| Technical Specification           |  |  |  |
|-----------------------------------|--|--|--|
| <b>Fog Light:</b> 1400 Lumens     | <b>Daytime Running Light:</b> 500 Lumens |  |  |
| <b>Position Light:</b> 225 Lumens | <b>Operating Voltage:</b> 12V - 24V      |  |  |
| <b>Color Temperature:</b> 6500k   |  |  |  |

|              |          |                                      |
|--------------|----------|--------------------------------------|
| <b>32594</b> | Chrome   | <b>Driver</b> - 1 Pc. / Color Box    |
| <b>32595</b> | Chrome   | <b>Passenger</b> - 1 Pc. / Color Box |
| <b>32596</b> | Blackout | <b>Driver</b> - 1 Pc. / Color Box    |
| <b>32597</b> | Blackout | <b>Passenger</b> - 1 Pc. / Color Box |

### For Peterbilt



### Chrome Steering Wheel Horn Pad for 2012+ Peterbilt

- Fits various 2012 and newer Peterbilt trucks, fits 579 trucks
- Features unique design to allow mounting of O.E. horn button emblem

**88036** 1 Pc. / Card

### Universal Products



### 33mm x 3 3/16" Bullet Nut Cover - Push-On (60/Pack)

- High quality chrome finish for durability and shine
- Fits over standard 33mm lug nuts on hub piloted wheel
- Designed to cover up and hide the lug nut flange washer
- Convenience pack, includes 60 nut cover to dress up your entire truck

**10117CB** 60 Pcs. / Color Box

### For Freightliner



### Bumper Reinforcement Aero Guard for 2018+ Freightliner Cascadia

- Fits both driver and passenger side
- Fits OEM number: 21-29000-000

**42477** 1 Pc. / Box

### Universal Products



### Chrome Air Valve Knob

- Heavy duty construction ensures strength and durability
- Ultra high quality chrome finish

**23699** **Ace of Spades** - 1 Pc. / Card

**23700** **Eagle** - 1 Pc. / Card

### Universal Products

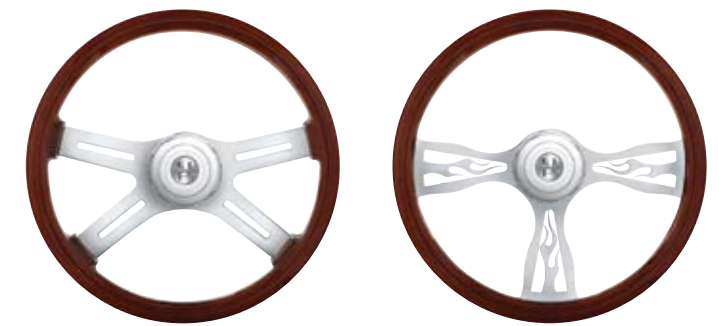

**88178**

**88180**



### 18" Wood Steering Wheel for 2006+ Peterbilt & 2003+ Kenworth Trucks

- Ready to install. Includes chrome horn button with bezel, and 40 spline steering shaft hub adapter
- Includes special steering shaft nut, horn contact wire and U.P. logo sticker

**88178** **4-Spoke** - 1 Pc. / Color Box

**88180** **Flame** - 1 Pc. / Color Box



**COMPETITION SERIES**

### Stainless 40" Heavy Duty Swivel Stick

- Heavy duty Stainless Steel swivel stick pipe with hose or cable holder
- 40 7/8" Length Pipe and 7/8" Diameter

**94011** 1 Pc. / Box

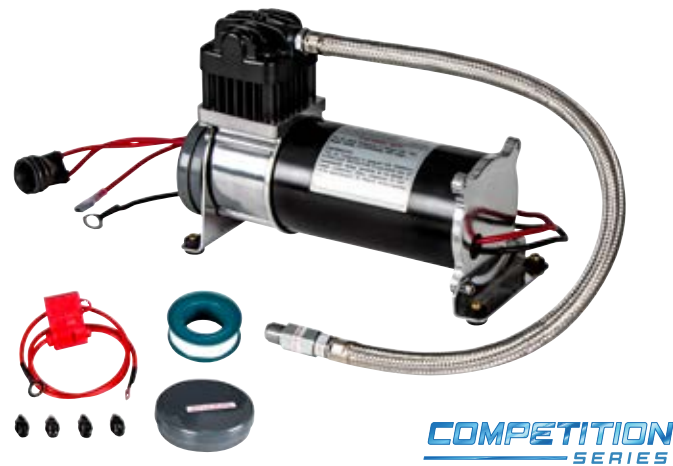

**COMPETITION SERIES**



### 12V 140 PSI Heavy Duty Air Compressor

- Excellent performance in a small form factor
- Design for general on-board air application such as air/train horns and off-road use
- Mounting brackets with vibration dampening brushing
- Kit includes air compressor, high pressure steel braided air hose, wiring harness with in-line fuse, air filter, and mounting hardware

**46156** 1 Set / Color Box



### 30' Extension Hose with Air Chuck and Air Blow Gun Kit

- Includes air chuck and chrome plated air blow gun
- Quality black nylon bag included

**89997** 1 Set / Bag

### For Kenworth

### NEW & IMPROVED



### Chrome Dome Light Cover for Kenworth Trucks

- Fits various Kenworth T600, T660, T800, and W900 Trucks
- Mounting screws included
- Fits OEM light # K256-601

**40985** 1 Pc. / Card

### NEW & IMPROVED



O-ring creates a tighter fit and reduces vibrations

### Chrome 1" Top LED Gearshift Mounting Adaptor for Eaton-Fuller 9 Speed Shifters

- Chrome diecast gearshift mounting adaptor for United Pacific CNC gear shift knobs
- New self-centering o-ring design, o-ring provided for a tighter fit and reduces vibration
- Fits all Eaton-Fuller 9 speed shifters
- LED light available separately, item number: 36897/36898, 36905/36906/36907/36908

**70665B** 1 Pc. / Bulk

# NEW ITEMS

April 2019

Headlight for Peterbilt 386/387, LED Headlight, Nut Cover Convenience Pack, and more...

### Peterbilt Headlight

**100%LED**

**DOT & SAE APPROVED**

**Dual Color LED Position Light Bar**



Dual color LED DRL/position light bar changes from white to amber when turn signal is activated

Dual Color LED Daytime Running Light and Turn Signal

Dual Color LED Position Light Bar



High Power LED High/Low Beam

LED Side Marker

### High Power LED Headlight with LED Turn Signal, LED Position Light, and LED Daytime Running Light for 2008+ Peterbilt 386/387

- Headlight assembly for Peterbilt 386/387 trucks
- High power 4 LED headlight with 73 LED DRL/position light and 72 LED turn signal
- Dual color LED DRL/position light bar changes from white to amber when turn signal activated
- Easy connection
- DOT/SAE headlight approved
- Sold individually, please specify driver or passenger side
- **3 year warranty**



### Technical Specification

| Low Beam Application | High Beam Application |
|----------------------|-----------------------|
| 1800 Lumens / 6300K  | 2500 Lumens / 6300K   |
| 2.2 Amps             | 2.7 Amps              |
| 12V DC Input         | 12V DC Input          |

**31082** Chrome **Driver** - 1 Pc. / Color Box  
**31083** Chrome **Passenger** - 1 Pc. / Color Box



**Universal Products**



**100%LED** **DOT & SAE APPROVED**

**Technical Specification**

| Low Beam Application                           | High Beam Application                          |
|--|--|
| 500 Lumens / 5700K<br>12V/24V Multiple Voltage | 950 Lumens / 5700K<br>12V/24V Multiple Voltage |

**High Power LED 7" Headlight with Polycarbonate Lens & Housing**

- High power 12 LED headlight for powerful performance
- Durable corrosion resistant polycarbonate lens & housing
- Solid state design resists shock and vibration
- DOT/SAE headlight compliant
- Easy connection, fits OEM housing, plugs into existing wiring harness, position light requires additional wiring

**31084** 1 Pc. / Card

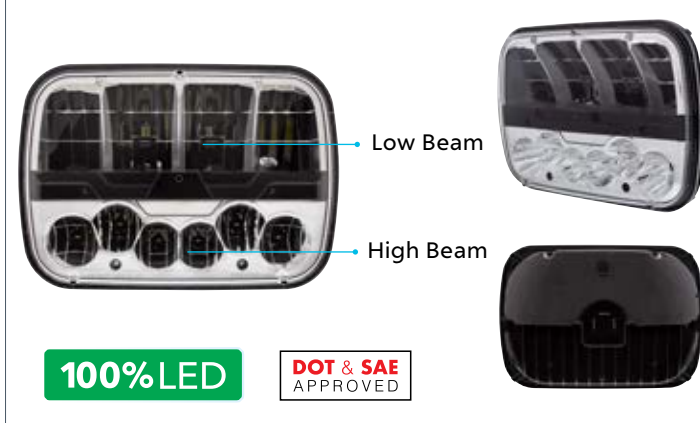

**100%LED** **DOT & SAE APPROVED**

**Technical Specification**

| Low Beam Application                           | High Beam Application                          |
|--|--|
| 500 Lumens / 5700K<br>12V/24V Multiple Voltage | 950 Lumens / 5700K<br>12V/24V Multiple Voltage |

**High Power LED 5"x 7" Headlight with Polycarbonate Lens & Housing**

- High power 12 LED headlight for powerful performance
- Durable corrosion resistant polycarbonate lens & housing
- Solid state design resists shock and vibration
- DOT/SAE headlight compliant
- Easy connection, fits OEM housing, plugs into existing wiring harness, position light requires additional wiring

**31087** 1 Pc. / Card



**100%LED** **DOT & SAE APPROVED**

**Technical Specification**

| Low Beam Application                           | High Beam Application                           |
|--|---|
| 800 Lumens / 6500K<br>12V/24V Multiple Voltage | 1000 Lumens / 6500K<br>12V/24V Multiple Voltage |

**High Power LED 4"x 6" Headlight with Polycarbonate Lens & Housing**

- High power 5 LED low beam headlight for powerful performance
- Durable corrosion resistant polycarbonate lens & housing
- Solid state design resists shock and vibration
- DOT/SAE headlight compliant
- Easy connection, fits OEM housing, plugs into existing wiring harness, position light requires additional wiring

**31088** **Low Beam** - 1 Pc. / Card

**31089** **High Beam** - 1 Pc. / Card

**60 60 PCS. CONVENIENCE PACK**



**33mm x 4 1/4" Tall Cylinder Nut Cover - Thread-On**

- High quality chrome finish for durability and shine
- Fits over standard 33mm lug nuts on hub piloted wheel
- Designed to cover up and hide the lug nut flange washer
- Convenience pack, includes 60 nut cover to dress up your entire truck

**10034CB** 60 Pcs. / Color Box

**60 60 PCS. CONVENIENCE PACK**



**33mm x 4" Extra Tall Nut Cover - Thread-On**

- High quality chrome finish for durability and shine
- Fits over standard 33mm lug nuts on hub piloted wheel
- Designed to cover up and hide the lug nut flange washer
- Convenience pack, includes 60 nut cover to dress up your entire truck

**10572CB** 60 Pcs. / Color Box

**60 60 PCS. CONVENIENCE PACK**



**33mm x 2 3/4" Original Nut Cover - Thread-On**

- High quality chrome finish for durability and shine
- Fits over standard 33mm lug nuts on hub piloted wheel
- Designed to cover up and hide the lug nut flange washer
- Convenience pack, includes 60 nut cover to dress up your entire truck

**10064CB** 60 Pcs. / Color Box

**60 60 PCS. CONVENIENCE PACK**



**33mm x 4 3/4" Super Spike Nut Cover - Thread-On**

- High quality chrome finish for durability and shine
- Fits over standard 33mm lug nuts on hub piloted wheel
- Designed to cover up and hide the lug nut flange washer
- Convenience pack, includes 60 nut cover to dress up your entire truck

**10569CB** 60 Pcs. / Color Box

**60 60 PCS. CONVENIENCE PACK**



**33mm x 4 1/8" Spike Nut Cover - Thread-On**

- High quality chrome finish for durability and shine
- Fits over standard 33mm lug nuts on hub piloted wheel
- Designed to cover up and hide the lug nut flange washer
- Convenience pack, includes 60 nut cover to dress up your entire truck

**10007CB** 60 Pcs. / Color Box

**60** 60 PCS. CONVENIENCE PACK



**33mm x 3 1/2" Cylinder Nut Cover - Push-On**

- High quality chrome finish for durability and shine
- Fits over standard 33mm lug nuts on hub piloted wheel
- Designed to cover up and hide the lug nut flange washer
- Convenience pack, includes 60 nut cover to dress up your entire truck

**10568CB** 60 Pcs. / Color Box

**60** 60 PCS. CONVENIENCE PACK



**33mm x 2 3/4" Original Nut Cover - Push-On**

- High quality chrome finish for durability and shine
- Fits over standard 33mm lug nuts on hub piloted wheel
- Designed to cover up and hide the lug nut flange washer
- Convenience pack, includes 60 nut cover to dress up your entire truck

**10265CB** 60 Pcs. / Color Box

**60** 60 PCS. CONVENIENCE PACK



**33mm x 3 1/4" Tall Classic Nut Cover - Push-On**

- High quality chrome finish for durability and shine
- Fits over standard 33mm lug nuts on hub piloted wheel
- Designed to cover up and hide the lug nut flange washer
- Convenience pack, includes 60 nut cover to dress up your entire truck

**10059CB** 60 Pcs. / Color Box

**60** 60 PCS. CONVENIENCE PACK



**33mm x 2 3/4" Bullet Nut Cover - Push-On**

- High quality chrome finish for durability and shine
- Fits over standard 33mm lug nuts on hub piloted wheel
- Designed to cover up and hide the lug nut flange washer
- Convenience pack, includes 60 nut cover to dress up your entire truck

**10049CB** 60 Pcs. / Color Box

**60** 60 PCS. CONVENIENCE PACK



**33mm x 4 7/8" Super Spike Nut Cover - Push-On**

- High quality chrome finish for durability and shine
- Fits over standard 33mm lug nuts on hub piloted wheel
- Designed to cover up and hide the lug nut flange washer
- Convenience pack, includes 60 nut cover to dress up your entire truck

**10570CB** 60 Pcs. / Color Box

**60** 60 PCS. CONVENIENCE PACK



**33mm x 4 1/8" Spike Nut Cover - Push-On**

- High quality chrome finish for durability and shine
- Fits over standard 33mm lug nuts on hub piloted wheel
- Designed to cover up and hide the lug nut flange washer
- Convenience pack, includes 60 nut cover to dress up your entire truck

**10770CB** 60 Pcs. / Color Box



**Chrome Dome Axle Cover Combo Kit w/ 33mm Thread-On Cylinder Nut Cover**

- High quality chrome finish for durability and shine
- Removable hub cap
- High impact, light weight corrosion resistant ABS plastic
- Kit includes:
  - Chrome finish front axle cover x 2
  - Chrome finish rear axle cover x 4
  - Chrome finish 33mm nut cover x 60

**10317** 1 Set / Color Box



**Chrome Pointed Axle Cover Combo Kit w/ 33mm Thread-On Cylinder Nut Cover**

- High quality chrome finish for durability and shine
- Removable hub cap
- High impact, light weight corrosion resistant ABS plastic
- Kit includes:
  - Chrome finish front axle cover x 2
  - Chrome finish rear axle cover x 4
  - Chrome finish 33mm nut cover x 60

**10318** 1 Set / Color Box

**For Freightliner Cascadia**

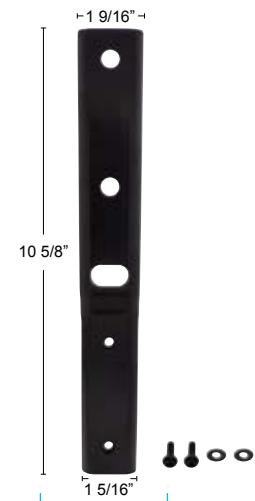

**Bumper Mesh Bracket for 2018+ Freightliner Cascadia**

- Fits both driver and passenger side
- Fits OEM number: A21-29039-000

**42485** 1 Pc. / Box

**NEW & IMPROVED**



**Chrome Interior Door Handle for Freightliner Trucks**

- Fits 2008-2013 Freightliner Cascadia, 2010-2013 Freightliner Coronado, 2003-2013 Freightliner M2
- Quality molded chrome plastic
- Design to look and function same as the original
- 42386 replaces OEM number A18-46490-000
- 42387 replaces OEM number A18-46490-001

**42386** Driver - 1 Pc. / Card  
**42387** Passenger - 1 Pc. / Card

**For Kenworth**



**Chrome Exterior Door Handle Cover for 2013+ Kenworth T680 & T880 Trucks**

- Easy installation with double sided tape mount
- 41542 - fits OEM number R56-1158
- 41543 - fits OEM number R56-1158R

**41542** Driver - 1 Pc. / Card  
**41543** Passenger - 1 Pc. / Card

**Universal Products**

**NEW & IMPROVED**



**Chromed Aluminum Gun Cylinder Gearshift Knob for Eaton Style Shifters**

- Ultra high quality chrome finish with 44MAG cartridge detail
- Heavy duty solid aluminum construction ensures strength and durability
- Easy installation

**70228** 9/10 Speed - 1 Pc. / Card  
**70229** 13/15/18 Speed - 1 Pc. / Card

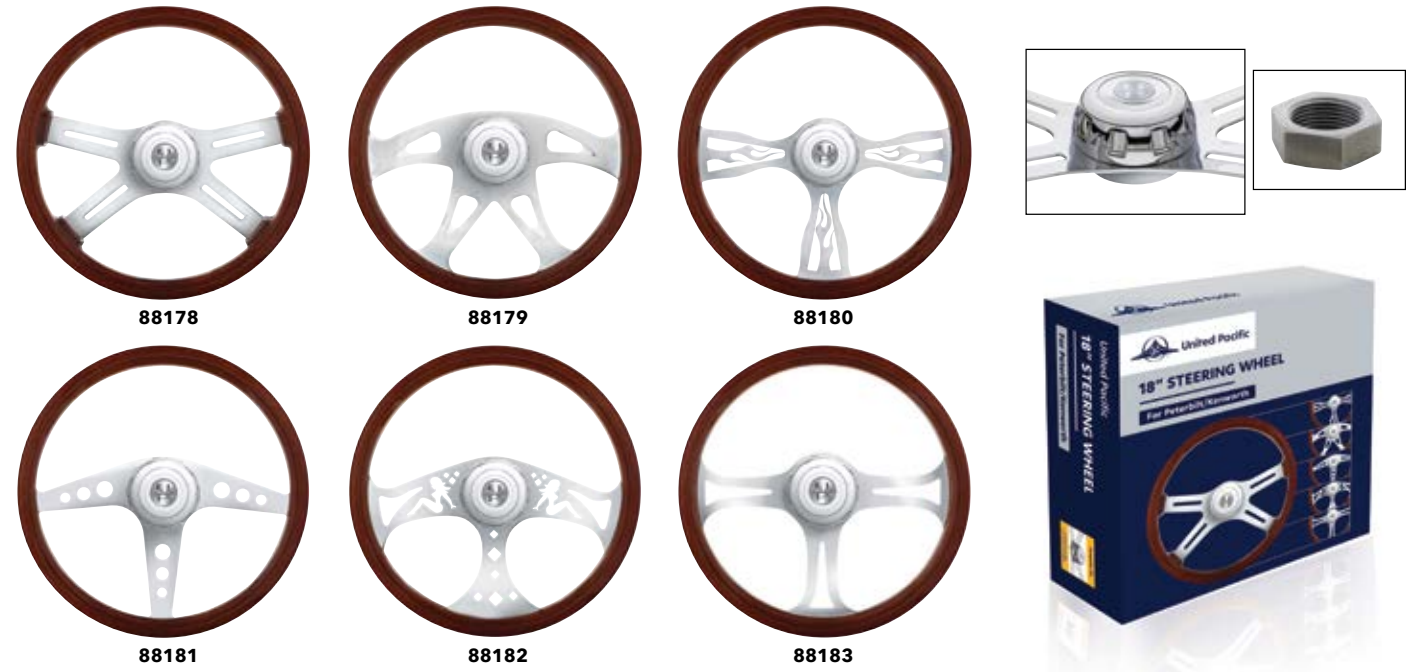

**18" Wood Steering Wheel for 2006+ Peterbilt & 2003+ Kenworth Trucks**

- Ready to install. Includes chrome horn button with bezel, and 40 spline steering shaft hub adapter
- Includes special steering shaft nut, horn contact wire and U.P. logo sticker

**88178** 4-Spoke - 1 Pc. / Color Box  
**88179 (NEW)** Boss - 1 Pc. / Color Box  
**88180** Flame - 1 Pc. / Color Box  
**88181 (NEW)** GT - 1 Pc. / Color Box  
**88182 (NEW)** Lady - 1 Pc. / Color Box  
**88183 (NEW)** Blade - 1 Pc. / Color Box



**Chrome Steering Wheel Hub & Horn Button Kit**

- Fits 1995-97 Kenworth, 1993-98 Peterbilt, and 1998-2012 Western Star
- Quality chrome plated diecast
- Fits any 3-Bolt United Pacific steering wheels
- Wheel with 36 spline center steering shaft mounting hole

**88291** 1 Pc. / Box



**Replacement Air Filter Element**

- Replacement air filter element for United Pacific item number 46154 & 46156 compressors

**46157** 2 Pcs. / Bag

**Recommended Item**



**For Ford Pickup**

**Chrome Spike Nut Cover For 2001-14 Ford F-Series - Push-On**

- Fits 1999-2004 Ford F-Series truck models with original steel wheel
- Spike is quality molded plastic with beautiful long lasting chrome plating
- 21mm x 3" push on

**10353B** 1 Pc. / Bulk

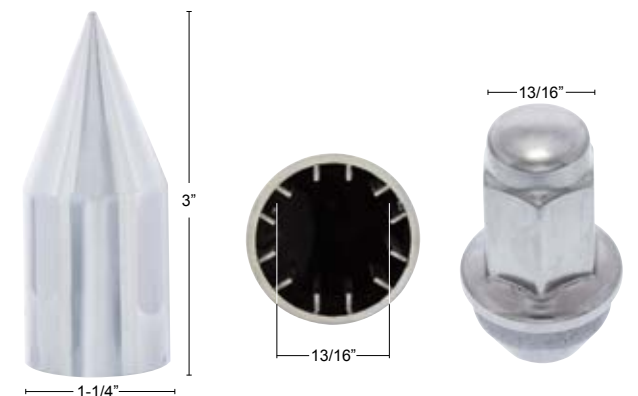

## Universal Products



### Poll Ball Gearshift Knob

- Beautiful gloss pool ball gearshift knob
- Brushed aluminum mounting base adapter
- Hex screw mount design, includes nylon reducing bushings to fit smaller shifters

|                    |                   |
|--------------------|-------------------|
| <b>70661</b>       | #1 - 1 Pc. / Card |
| <b>70662</b>       | #2 - 1 Pc. / Card |
| <b>70663</b>       | #3 - 1 Pc. / Card |
| <b>70754 (NEW)</b> | #4 - 1 Pc. / Card |
| <b>70755 (NEW)</b> | #5 - 1 Pc. / Card |
| <b>70756 (NEW)</b> | #6 - 1 Pc. / Card |
| <b>70757 (NEW)</b> | #7 - 1 Pc. / Card |
| <b>70025</b>       | #8 - 1 Pc. / Card |

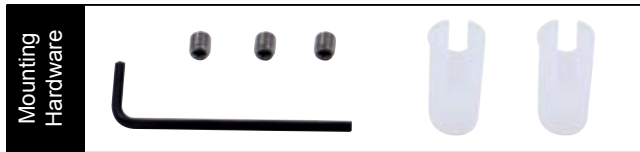

|                    |                    |
|--------------------|--------------------|
| <b>70758 (NEW)</b> | #9 - 1 Pc. / Card  |
| <b>70759 (NEW)</b> | #10 - 1 Pc. / Card |
| <b>70760 (NEW)</b> | #11 - 1 Pc. / Card |
| <b>70761 (NEW)</b> | #12 - 1 Pc. / Card |
| <b>70762 (NEW)</b> | #13 - 1 Pc. / Card |
| <b>70763 (NEW)</b> | #14 - 1 Pc. / Card |
| <b>70764 (NEW)</b> | #15 - 1 Pc. / Card |



### Poll Ball Shift Knob for 13/15/18 Speed Eaton Style Shifters

- Beautiful gloss pool ball with chrome plated Eaton style gear shifter base
- Includes chrome mounting adapter, set screws, hex wrench and instruction sheet
- Mounting adaptor item number 70603B available separately

|                    |                   |
|--------------------|-------------------|
| <b>70687</b>       | #1 - 1 Pc. / Card |
| <b>70688</b>       | #2 - 1 Pc. / Card |
| <b>70689</b>       | #3 - 1 Pc. / Card |
| <b>70765 (NEW)</b> | #4 - 1 Pc. / Card |
| <b>70766 (NEW)</b> | #5 - 1 Pc. / Card |
| <b>70767 (NEW)</b> | #6 - 1 Pc. / Card |
| <b>70768 (NEW)</b> | #7 - 1 Pc. / Card |
| <b>70685</b>       | #8 - 1 Pc. / Card |



|                    |                    |
|--------------------|--------------------|
| <b>70769 (NEW)</b> | #9 - 1 Pc. / Card  |
| <b>70770 (NEW)</b> | #10 - 1 Pc. / Card |
| <b>70771 (NEW)</b> | #11 - 1 Pc. / Card |
| <b>70772 (NEW)</b> | #12 - 1 Pc. / Card |
| <b>70773 (NEW)</b> | #13 - 1 Pc. / Card |
| <b>70774 (NEW)</b> | #14 - 1 Pc. / Card |
| <b>70775 (NEW)</b> | #15 - 1 Pc. / Card |

# NEW ITEMS

May 2019

## Chrome Aluminum Steering Wheel, Chrome Oval Emblem and more...



### 18" CHROME ALUMINUM STEERING WHEEL

with premium leather or hand crafted wood rim

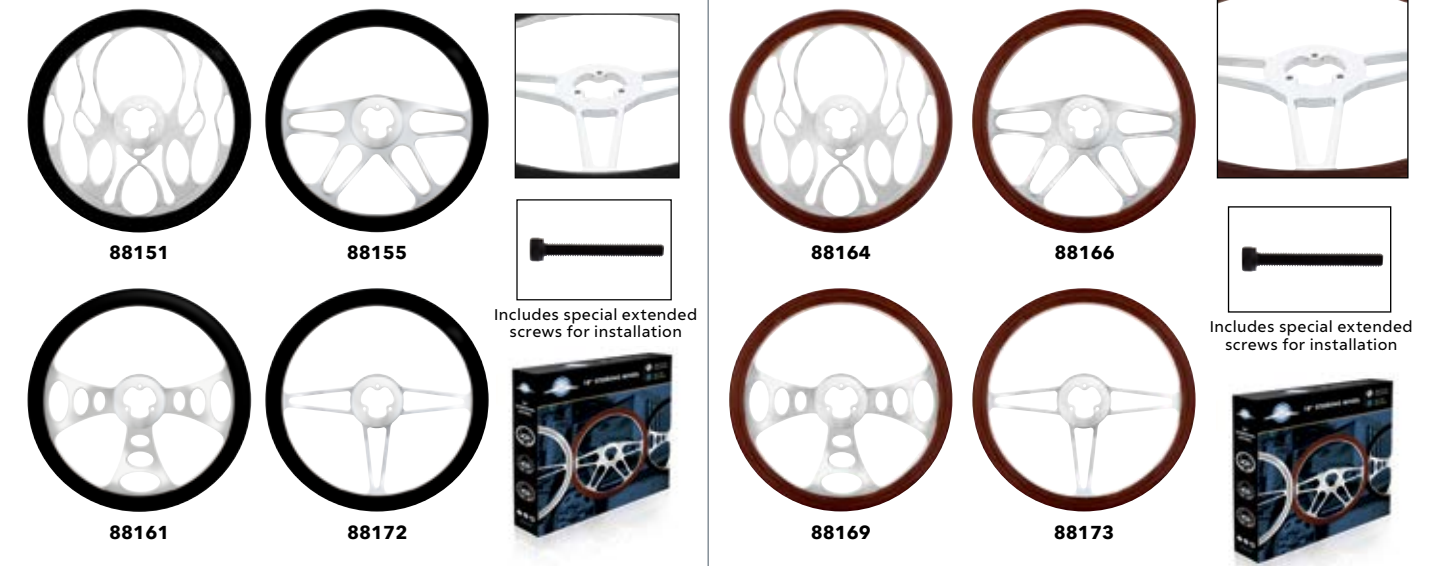

### 18" Chrome Aluminum Steering Wheel with Black Leather Rim

- Premium black leather steering wheel rim
- High quality CNC aluminum with chrome plating
- Steering wheel only. Hub and horn button assembly available separately
- Mix and match with United Pacific hubs and designer horn bezels for a unique and distinctive look

|              |                                    |
|--------------|------------------------------------|
| <b>88151</b> | <b>Blaze</b> - 1 Pc. / Color Box   |
| <b>88155</b> | <b>4 Spoke</b> - 1 Pc. / Color Box |
| <b>88161</b> | <b>Chopper</b> - 1 Pc. / Color Box |
| <b>88172</b> | <b>3 Spoke</b> - 1 Pc. / Color Box |

### 18" Chrome Aluminum Steering Wheel with Wood Rim

- Hand crafted wood steering wheel rim
- High quality CNC aluminum with chrome plating
- Steering wheel only. Hub and horn button assembly available separately
- Mix and match with United Pacific hubs and designer horn bezels for a unique and distinctive look

|              |                                    |
|--------------|------------------------------------|
| <b>88164</b> | <b>Blaze</b> - 1 Pc. / Color Box   |
| <b>88166</b> | <b>4 Spoke</b> - 1 Pc. / Color Box |
| <b>88169</b> | <b>Chopper</b> - 1 Pc. / Color Box |
| <b>88173</b> | <b>3 Spoke</b> - 1 Pc. / Color Box |



**Universal Products**



**18" Wood Steering Wheel for 2006+ Peterbilt & 2003+ Kenworth Trucks with Hub and Skull Accent**

- Ready to install. Includes chrome horn button with bezel, and 40 spline steering shaft hub adapter
- Includes special steering shaft nut, horn contact wire and U.P. logo sticker
- Warning: 2014+ Peterbilt & Kenworth equipped with steering angle sensor & stability control require special installation. Consult installation instruction sheet to prevent vehicle damage

**88184** 1 Pc. / Color Box

**For Ford Pickup**



**Chrome Spike Nut Cover for 2004 - 2014 Ford F-Series with OE Steel Wheel -Push-On**

- Molded with quality plastic material
- Beautiful long lasting chrome plating
- Will fit any 13/16" (21mm) wheel lug nuts
- 21mm x 3" push-on type fitting

**10352B** 1 Pc. / Bulk

**For Freightliner Cascadia**



**Chrome Mirror Post Cover for 2007 - 2017 Freightliner Cascadia Classic**

- Chrome plastic mirror post cover for Freightliner Cascadia
- Fits OE mirror A22-60713-001, A22-60713-002, A22-60713-003, A22-60713-005
- Easy installation with double sided tape

**42373** 1 Set / Card

**For Harley Davidson**

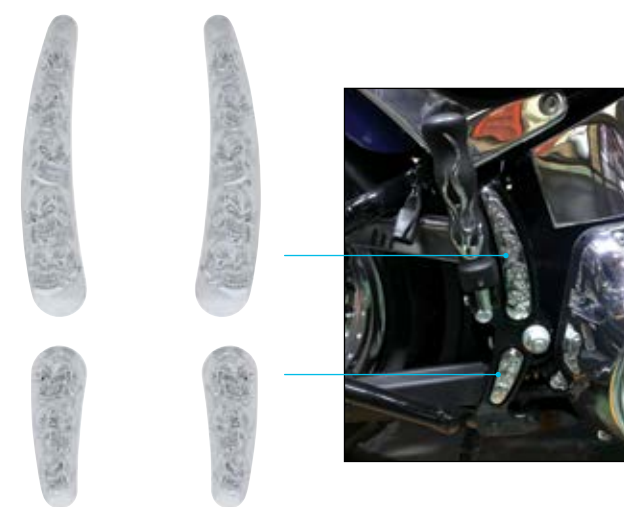

**Skull Swing Arm Accent Set**

- Fits 2008-17 Harley-Davidson Softtail models (except FXCW, FXCWC, FXSB, and FXSBSE)
- Unique four-piece skull accent set to dress up the recessed area in the rear swing arm frame
- Easy to install with pressure sensitive adhesive mounting
- Beautifully chrome plated plastic injection molded
- Add a little attitude to your ride

**52010** 1 Set / Card

**Chrome Emblem**



**Chrome Die Cast Emblem**

- Die cast & beautifully chrome plated oval emblem
- 7 7/8" x 3 1/4", aluminum flag decal
- Mounting studs are 6 1/4" apart and speed nuts are included
- Sold each

|              |   |
|--------------|---|
| <b>10881</b> | <b>Chrome Skull</b> - 1 Pc. / Card <b>(NEW)</b> |
| <b>10882</b> | <b>Black Skull</b> - 1 Pc. / Card <b>(NEW)</b>  |
| <b>10883</b> | <b>Blue Skull</b> - 1 Pc. / Card <b>(NEW)</b>   |
| <b>10884</b> | <b>Red Skull</b> - 1 Pc. / Card <b>(NEW)</b>    |
| <b>10924</b> | <b>Mexico</b> - 1 Pc. / Card                    |
| <b>10934</b> | <b>Texas</b> - 1 Pc. / Card                     |
| <b>10945</b> | <b>USA</b> - 1 Pc. / Card                       |

|              |   |
|--------------|---|
| <b>10946</b> | <b>Confederate</b> - 1 Pc. / Card                 |
| <b>10972</b> | <b>Alabama</b> - 1 Pc. / Card <b>(NEW)</b>        |
| <b>10973</b> | <b>Arkansas</b> - 1 Pc. / Card <b>(NEW)</b>       |
| <b>10974</b> | <b>Colorado</b> - 1 Pc. / Card <b>(NEW)</b>       |
| <b>10975</b> | <b>North Carolina</b> - 1 Pc. / Card <b>(NEW)</b> |
| <b>10976</b> | <b>Tennessee</b> - 1 Pc. / Card <b>(NEW)</b>      |
| <b>10977</b> | <b>Canada</b> - 1 Pc. / Card <b>(NEW)</b>         |

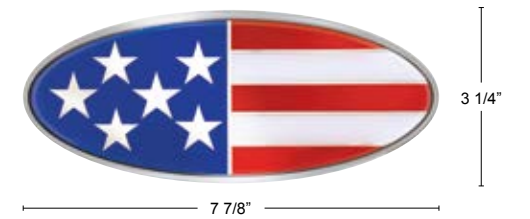

**Merchandising**



**United Pacific Steering Wheel Display - Type III**

- Includes United Pacific steering wheel: item number 88150/88217
- Includes United Pacific chrome hub/horn button: item number 88223/88261/88120

**99138** 1 Set / Box



**United Pacific Steering Wheel Display - Type V**

- Includes United Pacific steering wheel: item number 88160/88257
- Includes United Pacific chrome hub/horn button: item number 88216/88261/88120

**99140** 1 Set / Box



**United Pacific Steering Wheel Display - Type IV**

- Includes United Pacific steering wheel: item number 88154/88217
- Includes United Pacific chrome hub/horn button: item number 88216/88261/88120

**99139** 1 Set / Box



**United Pacific Steering Wheel Display - Type VI**

- Includes United Pacific steering wheel: item number 88171/88257
- Includes United Pacific chrome hub/horn button: item number 88216/88261/88120

**99141** 1 Set / Box



### United Pacific Gearshift Knob Display

- United Pacific gearshift knob display

**99144** 1 Set / Box



### Auto Trim Removal Pry Tool Kit - 4pcs/Kit

- Four-piece kit with different ends to help remove many types of molding, door panels, trims, and dashboards with ease
- Constructed of durable nylon fiber that does not break or bend like ABS plastic
- Soft curve surface prevents accidental scratches or damage to the vehicle or trim

**99135** 1 Set / Box

## NEW & IMPROVED



### United Pacific Gearshift Knob Display

- United Pacific gearshift knob display
- Gearshift knobs sold separately

**99072** 1 Pc. / Box

## Available Now!



2018 New Item Flyer Collection  
Item # UF1218



Truck Stainless Steel Catalog  
Item # UCS51

# NEW ITEMS

June 2019

## Headlight for Peterbilt 386/387, 388/389, Chrome Bottom Mud Flap and more...

### Peterbilt Headlight

**100%LED**

**DOT & SAE  
APPROVED**

**Dual Color LED  
Position Light Bar**

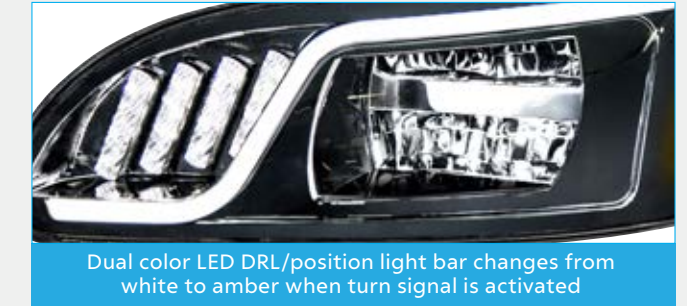

Dual color LED DRL/position light bar changes from white to amber when turn signal is activated

Dual Color LED  
Daytime Running Light  
and Turn Signal

Dual Color LED  
Position Light Bar



High Power LED  
High/Low Beam

LED  
Side Marker

### High Power LED Headlight with LED Turn Signal, LED Position Light, and LED Daytime Running Light for 2008+ Peterbilt 386/387

- Headlight assembly for Peterbilt 386/387 trucks
- High power 4 LED headlight with 73 LED DRL/position light and 72 LED turn signal
- Dual color LED DRL/position light bar changes from white to amber when turn signal activated
- Easy connection
- DOT/SAE headlight approved
- Sold individually, please specify driver or passenger side
- **3 year warranty**

## New Blackout Design



### Technical Specification

| Low Beam Application | High Beam Application |
|----------------------|-----------------------|
| 1800 Lumens / 6300K  | 2500 Lumens / 6300K   |
| 2.2 Amps             | 2.7 Amps              |
| 12V DC Input         | 12V DC Input          |

|              |                |                               |
|--------------|----------------|-------------------------------|
| <b>31073</b> | Blackout (NEW) | Driver - 1 Pc. / Color Box    |
| <b>31074</b> | Blackout (NEW) | Passenger - 1 Pc. / Color Box |
| <b>31082</b> | Chrome         | Driver - 1 Pc. / Color Box    |
| <b>31083</b> | Chrome         | Passenger - 1 Pc. / Color Box |



## Peterbilt Headlight

**100%LED**

**DOT & SAE APPROVED**

**Patent Pending Unique Lens Design**

**Dual Color LED Position Light Bar**

**New Chrome Design**

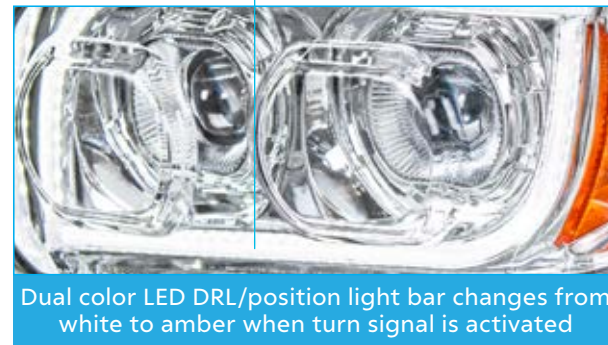

### High Power LED Headlight with LED Position Light & LED Turn Signal for 2008+ Peterbilt 388/389

- High power LED headlight with 57 LED position light and 16 LED turn signal
- Bold and unique headlight design. Patent pending design
- Headlight assembly for Peterbilt 388/389 trucks
- Dual color LED position light bar changes from white to amber when turn signal activated
- Patent pending unique lens design
- Easy connection, plugs into existing wiring harness
- DOT/SAE headlight approved
- Sold individually, please specify driver or passenger side
- **3 years warranty**



#### Technical Specification

| Low Beam Application | High Beam Application |
|----------------------|-----------------------|
| 1600 Lumens          | 2400 Lumens           |
| 1.25 Amps            | 1.25 Amps             |
| 12V DC Input         | 12V DC Input          |

|              |              |                                      |
|--------------|--------------|--------------------------------------|
| <b>31144</b> | Chrome (NEW) | <b>Driver</b> - 1 Pc. / Color Box    |
| <b>31145</b> | Chrome (NEW) | <b>Passenger</b> - 1 Pc. / Color Box |
| <b>31146</b> | Blackout     | <b>Driver</b> - 1 Pc. / Color Box    |
| <b>31147</b> | Blackout     | <b>Passenger</b> - 1 Pc. / Color Box |



### 18" Chrome Aluminum "Scorpion" Steering Wheel

- 18" Chrome Aluminum "Scorpion" Steering Wheel
- High quality CNC aluminum with chrome plating
- Steering wheel only. Hub and horn button assembly available separately
- Mix and match with United Pacific hubs and designer horn bezels for a unique and distinctive look

|              |  |
|--------------|--|
| <b>88158</b> | <b>Chrome Rim</b> - 1 Pc. / Color Box        |
| <b>88159</b> | <b>Black Leather Rim</b> - 1 Pc. / Color Box |
| <b>88168</b> | <b>Wood Rim</b> - 1 Pc. / Color Box          |

### For Kenworth T680/T880



### Stainless 8" Chopped Window Trim for Kenworth T680/T880 Trucks

- Fits 2013 and newer Kenworth T680 & T880 trucks
- Easy to install pressure sensitive adhesive mounting
- Mirror like 304 high grade stainless steel
- Includes 1 left and 1 right side trim
- Does not have cutout for passenger side upper mirror

**29057** - 1 Pair / Color Box



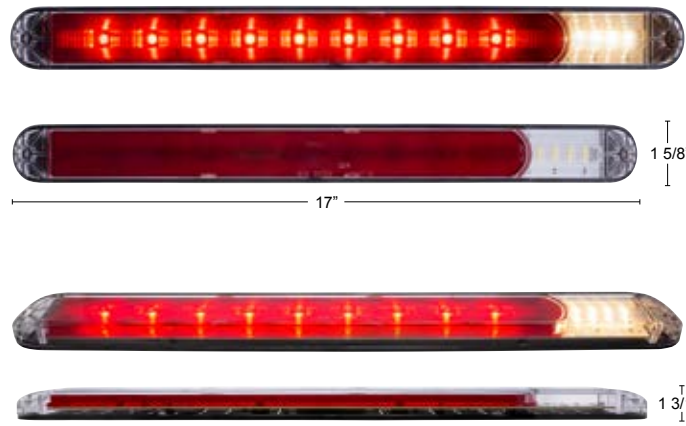

### 9 Red LED 17" Light Bar With 4 White LED Back Up Light

- 4 in 1 function LED tail light bar with LED Stop/Turn/Tail and LED backup light
- Hard wired with 4 wires, 12 volt
- Perfect for trailers, or below tailgate on pickups
- Approximate size 17" x 1-5/8" x 1-3/16"
- Surface mount. mounting holes 16-1/8" center to center

**36499B** 1 Pc. / Bulk

### For Peterbilt 579/567



### Chrome Door Handle Cover for Peterbilt 567/579

- Easy installation with double sided tape mount
- Installation tip: apply small amount of RTV silicon glue inside four corners for a more secure fit
- Show winning shine
- Fits OEM# R56-1159 & 16916603 (driver)/ R56-1159R & 16916602 (passenger)

**41749** **Driver** - 1 Pc. / Card

**41750** **Passenger** - 1 Pc. / Card



### Chrome Bronco Key Chain/Bottle Opener

- Beautiful highly detailed life-like bucking bronco
- Quality chrome plated die cast with triple chrome plating process
- Heavy duty, quality you can feel
- Features a special designed cut out at the rear to work as a bottle opener
- Round split keychain ring included

**99102** 1 Pc. / Card

### For Freightliner Cascadia



### Chrome Door Handle Cover For 2018+ Freightliner Cascadia

- Fits 2018 and newer Freightliner Cascadia trucks
- Sold Individually, please specify driver or passenger side
- Easy installation with double sided tape

**42428** **Driver** - 1 Pc. / Card

**42429** **Passenger** - 1 Pc. / Card



### 4"x 24" Chrome Bottom Mud Flap Weight With Oval Emblem

- Unique chrome die cast oval emblem mounted on chrome mud flap weight
- Mounts to mud flap with hidden stud welded on back side
- Mounting hardware included. Sold Each

**67008** **USA** - 1 Pc. / Skin Pack

**67009** **Texas** - 1 Pc. / Skin Pack

**67010** **Mexico** - 1 Pc. / Skin Pack

**67011** **Confederate** - 1 Pc. / Skin Pack

**67012** **Skull** - 1 Pc. / Skin Pack

**67013** **Eagle** - 1 Pc. / Skin Pack

**67014** **Alabama** - 1 Pc. / Skin Pack (NEW)

**67015** **Arkansas** - 1 Pc. / Skin Pack (NEW)

**67016** **Colorado** - 1 Pc. / Skin Pack (NEW)

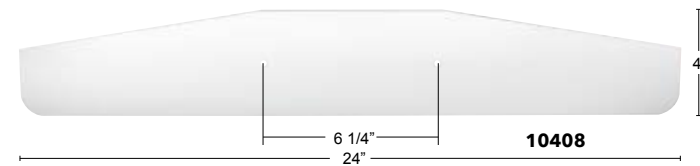
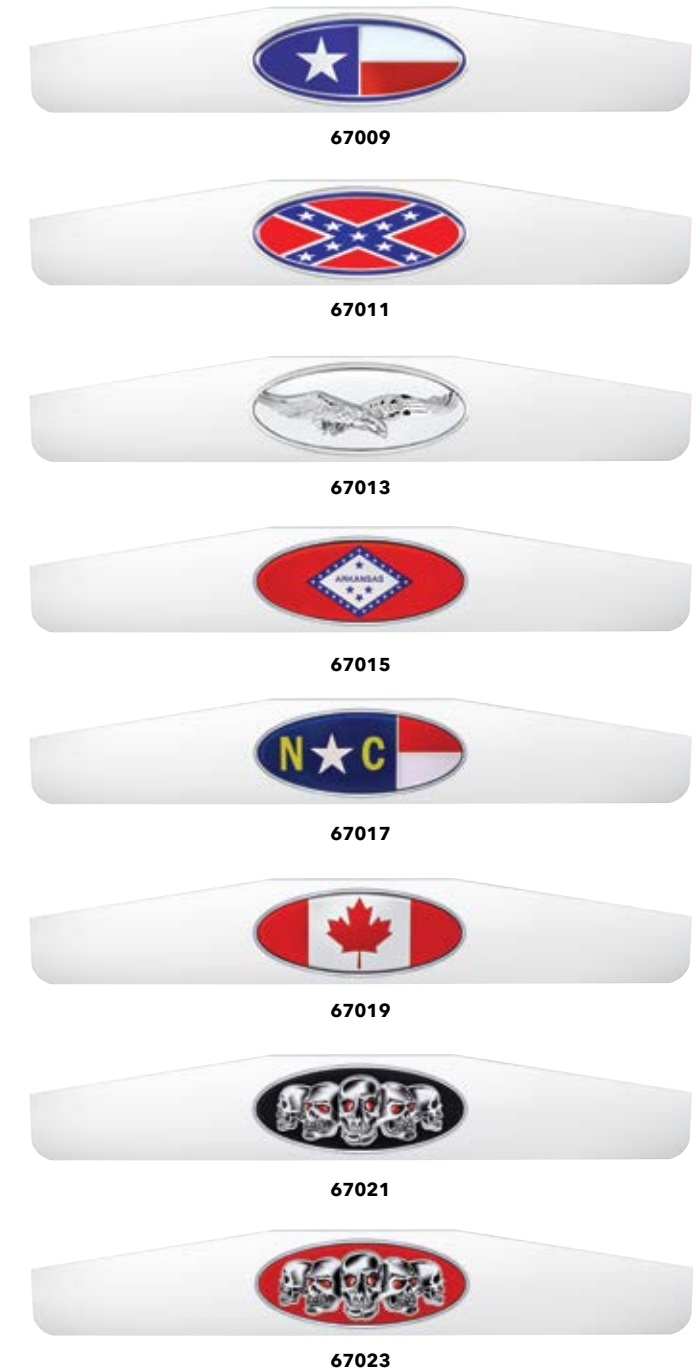

**67017** **North Carolina** - 1 Pc. / Skin Pack (NEW)

**67018** **Tennessee** - 1 Pc. / Skin Pack (NEW)

**67019** **Canada** - 1 Pc. / Skin Pack (NEW)

**67020** **Chrome Skull** - 1 Pc. / Skin Pack (NEW)

**67021** **Black Skull** - 1 Pc. / Skin Pack (NEW)

**67022** **Blue Skull** - 1 Pc. / Skin Pack (NEW)

**67023** **Red Skull** - 1 Pc. / Bulk (NEW)

**10408** **Plain with emblem cutout** - 1 Pc. / Bulk

# NEW ITEMS

July 2019

## Steering Wheel Horn Bezel, Chrome Die Cast Flag Emblem and more...



|              |                                       |
|--------------|---------------------------------------|
| <b>88284</b> | <b>Indigo Blue</b> - 1 Pc. / Card     |
| <b>88285</b> | <b>Emerald Green</b> - 1 Pc. / Card   |
| <b>88286</b> | <b>Cadmium Orange</b> - 1 Pc. / Card  |
| <b>88287</b> | <b>Candy Red</b> - 1 Pc. / Card       |
| <b>88288</b> | <b>Liquid Silver</b> - 1 Pc. / Card   |
| <b>88289</b> | <b>Electric Yellow</b> - 1 Pc. / Card |
| <b>88290</b> | <b>Pearl White</b> - 1 Pc. / Card     |

### Steering Wheel Horn Bezel

- Premium automotive paint with vibrant candy pearl color
- Fits steering wheels that use 3-hole hub adaptor
- Horn button available separately, item #88120
- Matching gearshift knobs, shifter shaft extensions, and air valve knobs available



### 30" Black "Competition Series" Heavy Duty Mud Flap Hanger - 2" Bolt Pattern

- Black 30" heavy duty spring loaded mud flap hanger, competition series
- 2" bolt pattern
- Stainless steel end plug available separately: item # 20611

**11321** 1 Pair / Color Box

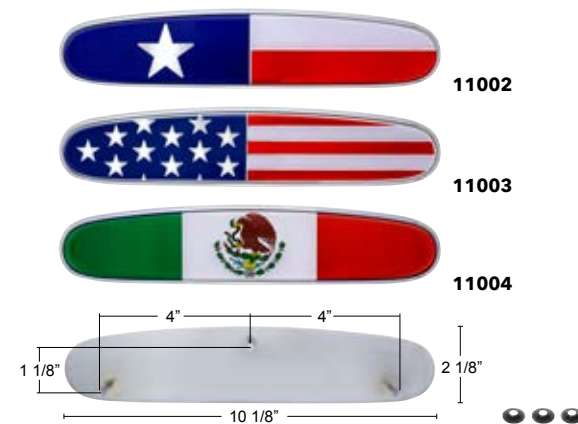

### Chrome Die Cast Flag Emblem

- Metal die cast zinc with quality chrome plating
- Beautifully decorated colors
- Emblem measures 10-1/8" x 2-1/8"
- Three mounting studs on back approximately 4" apart with speed nuts included
- Fits various Freightliner truck models

|              |                              |
|--------------|------------------------------|
| <b>11002</b> | <b>Texas</b> - 1 Pc. / Card  |
| <b>11003</b> | <b>USA</b> - 1 Pc. / Card    |
| <b>11004</b> | <b>Mexico</b> - 1 Pc. / Card |

# NEW ITEMS

August 2019

## Headlight for International Prostar and more...

### International Headlight

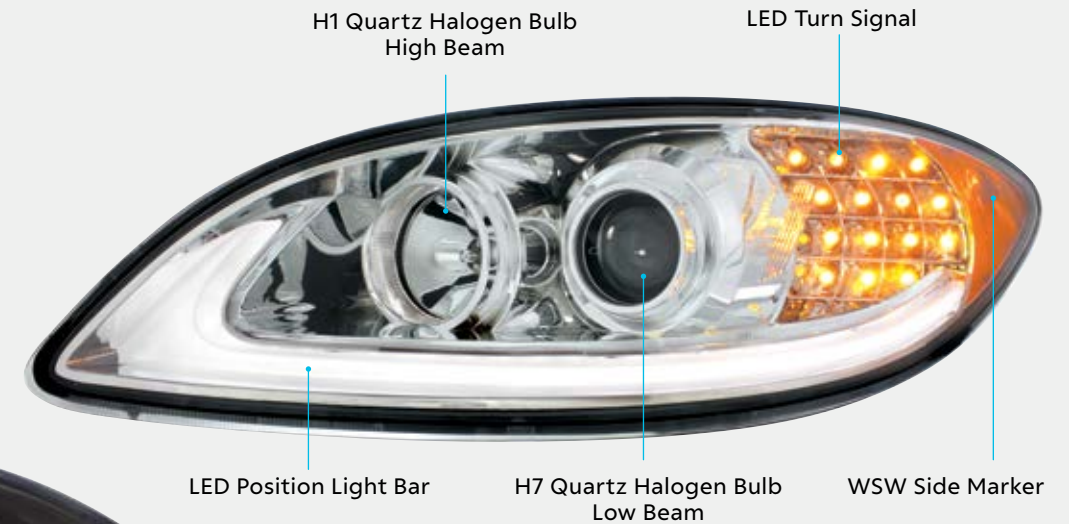

**DOT**

### High Power Projection Headlight with LED Light Bar & LED Turn Signal for International Prostar

- Projection Headlight with LED Position Light Bar
- Unique LED turn signal with LED Position Light Bar Design
- Easy connection, plugs into existing wiring harness
- DOT/SAE headlight approved
- Sold individually, please specify driver or passenger side
- **3 year warranty**



### Technical Specification

| Low Beam Application | High Beam Application |
|----------------------|-----------------------|
| H7 / 55 Watt         | H1 / 55 Watt          |
| 4.58 Amps            | 4.58 Amps             |
| 12V DC Input         | 12V DC Input          |

|              |          |                                      |
|--------------|----------|--------------------------------------|
| <b>31175</b> | Chrome   | <b>Driver</b> - 1 Pc. / Color Box    |
| <b>31176</b> | Chrome   | <b>Passenger</b> - 1 Pc. / Color Box |
| <b>31177</b> | Blackout | <b>Driver</b> - 1 Pc. / Color Box    |
| <b>31178</b> | Blackout | <b>Passenger</b> - 1 Pc. / Color Box |



## International Headlight



**DOT**

### High Power Projection Headlight with LED Light Bar for International Prostar

- Projection Headlight with LED Position Light Bar
- Unique LED Position Light Bar Design
- Easy connection, plugs into existing wiring harness
- DOT/SAE headlight approved
- Sold individually, please specify driver or passenger side
- **3 years warranty**



| Technical Specification |                       |
|-------------------------|-----------------------|
| Low Beam Application    | High Beam Application |
| H7 / 55 Watt            | H1 / 55 Watt          |
| 4.58 Amps               | 4.58 Amps             |
| 12V DC Input            | 12V DC Input          |

|              |          |                                      |
|--------------|----------|--------------------------------------|
| <b>31179</b> | Chrome   | <b>Driver</b> - 1 Pc. / Color Box    |
| <b>31180</b> | Chrome   | <b>Passenger</b> - 1 Pc. / Color Box |
| <b>31183</b> | Blackout | <b>Driver</b> - 1 Pc. / Color Box    |
| <b>31184</b> | Blackout | <b>Passenger</b> - 1 Pc. / Color Box |



## Universal Products

**COMPETITION**  
SERIES



**36459**

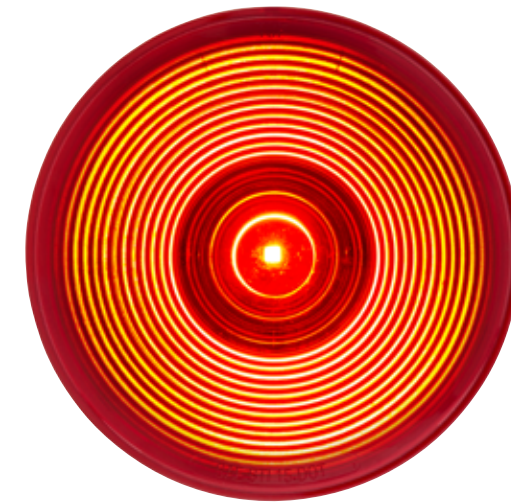

**36460**



### LED 4" Light

- Single LED 4" round S/T/T light
- 3 contact female plug
- DOT/SAE approved
- Recommended plug: Item # 34212/34216

**36459**

**Red** - 1 Pc. / Bulk

**36460**

**Amber** - 1 Pc. / Bulk

**Plug & Play**

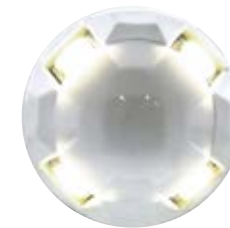

**38897**



**38898**



**38899**



### High Power 8 LED 1156 Bulb

- 8 High Power SMD LED's
- Replaces most #1156 and #89 applications
- 12 Volt, single contact with straight-across pins

**38897**

**White / 250 lm** - 2 Pcs. / Color Box

**38898**

**Red / 150 lm** - 2 Pcs. / Color Box

**38899**

**Amber / 150 lm** - 2 Pcs. / Color Box

**SPECIAL EDITION**

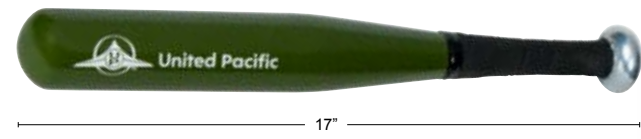

**P-40 "Warhawk" Shark Mouth 17" Tire Checking Bat**

- Aluminum tire checker in military green with WWII P40 style shark mouth decal
- 17" long with comfortable anti-slip grip



**99136** 1 Pc. / Box



**10241-1**



**10278-1**

**Chrome Pointed Axle Hub Cap**

- 10241-1 - replacement hub cap for # 10254 & 10241
- 10278-1 - replacement hub cap for # 10261 & 10278

**10241-1** **Front Axle** - 1 Pc. / Bulk  
**10278-1** **Rear Axle** - 1 Pc. / Bulk

**NEW PACKAGING**



**Chrome Plastic 2 Bar Hub Cap Spinner Only**

- Chrome Plastic Spinner
- 2-bar California "groovy" style
- Mounts with 5/16-18 thread
- Show winning shine

**10724** 1 Pc. / Card

**NEW ITEMS**

September 2019

**4 Spoke Steering Wheel, High Power LED Rectangular Light and more...**

**18" 4 Spoke Steering Wheel**



**18" 4 Spoke Color Steering Wheel**

- Premium automotive paint in vibrant candy colors, bold effects and dazzling color
- High quality steel with chrome plating
- Steering wheel only, commercial 3-bolt hub and horn button/bezel assembly available separately
- Mix and match with U.P. designer horn bezels, gearshift knobs, shifter shaft extensions and air valve knobs, available separately

|              |   |
|--------------|---|
| <b>88277</b> | <b>Indigo Blue</b> - 1 Pc. / Color Box <b>(NEW)</b>     |
| <b>88278</b> | <b>Emerald Green</b> - 1 Pc. / Color Box <b>(NEW)</b>   |
| <b>88279</b> | <b>Cadmium Orange</b> - 1 Pc. / Color Box <b>(NEW)</b>  |
| <b>88280</b> | <b>Candy Red</b> - 1 Pc. / Color Box <b>(NEW)</b>       |
| <b>88282</b> | <b>Electric Yellow</b> - 1 Pc. / Color Box <b>(NEW)</b> |
| <b>88283</b> | <b>Pearl White</b> - 1 Pc. / Color Box <b>(NEW)</b>     |
| <b>88248</b> | <b>Flame</b> - 1 Pc. / Color Box                        |



**33mm x 2-5/8" Chrome Plastic Bullet Nut Cover w/ Flange - Push-On**

- High quality chrome finish for durability and shine
- Fits over standard 33mm lug nuts on hub piloted wheel
- Designed to cover up and hide the lug nut flange washer
- Convenience pack, includes 60 nut covers to dress up your entire truck

**60 60 PCS. CONVENIENCE PACK**

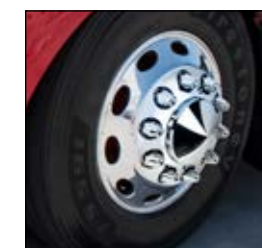

**10060CB** 60 Pcs. / Color Box



### 18 High Power 4"X 6" LED Rectangular Light With Position Light - Black

- LED dual function rectangular light with 10 white LED position lights
- Ultra slim housing design for easier installation
- High beam: 3500 Lumens/6500K; Low beam: 1500 lumens/6500K; Position light: 100 lumens
- Rugged anti-vibration construction
- 12VDC - 24VDC
- IP67 Water resistant rating
- Easy connection, fits OEM housing or fender, plugs into existing wiring harness, position light requires additional wiring
- Off-Road use only

**36449** 1 Pc. / Color Box



**100%LED**

### 22 High Power 5"X 7" LED Rectangular Light With Position Light - Black

- LED dual function rectangular light with 12 white LED position lights
- Ultra slim housing design for easier installation
- High beam: 4000 lumens; Low beam: 2000 lumens; Position light: 100 lumens
- Rugged anti-vibration construction
- 12VDC - 24VDC
- IP67 Water resistant rating
- Easy connection, fits OEM housing or fender, plugs into existing wiring harness, position light requires additional wiring
- Off-Road use only

**36450** 1 Pc. / Color Box



**100%LED**



### Aluminum Front Fender For Peterbilt 357/ 379

- Made of high quality 14 gauge aluminum and pre-primed
- Pre-drilled holes on mounting edge - ready to install
- OEM reference no.15-04905M001L, 15-04905M001RL, FN4905L
- Inside Liner Not Included

**11020** Driver - 1 Pc. / Box

**11021** Passenger - 1 Pc. / Box

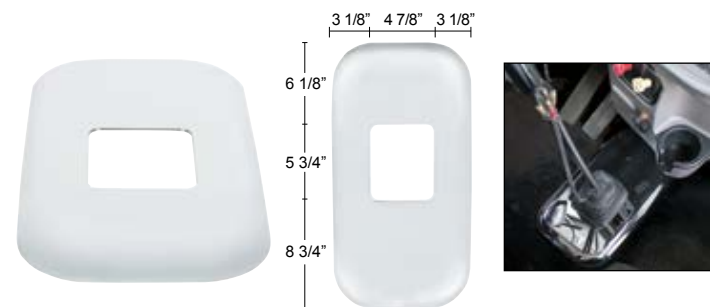

### Chrome Shift Plate Cover for Peterbilt Trucks

- Chrome plastic shift plate cover for Peterbilt 386/ 388/ 389/ 567/ 579/ 587
- Fits OEM S22-6041M01-201

**41787B** 1 Pc. / Box



### Chrome A/C Knob for 2012+ Peterbilt 579 trucks

- Direct aftermarket replacement for OEM
- For easy installation, use of non-marking plastic pry tool is recommended, U.P. item# 99135
- Sold individually

**41762** 1 Pc. / Card



### Chrome Gauge Blank for 2018+ Freightliner Cascadia

- Direct aftermarket replacement for OEM: 22-73998-000
- Easy installation, fits 2-1/6" (52mm) gauge holes
- Sold individually

**42422** 1 Pc. / Card

### Stainless Steel 7" Headlight Retaining Ring

- 7" Stainless steel headlight retaining ring
- Direct-fit replacement without trimming
- 304 stainless steel

**30620B** 1 Pc. / Bulk

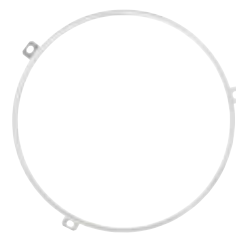

# NEW ITEMS

October 2019

## 60 PCS. CONVENIENCE PACK



### 33mm x 3-1/8" Chrome Plastic Spike Nut Cover - Push-On (60/Pack)

- High quality chrome finish for durability and shine
- Fits over standard 33mm lug nuts on hub piloted wheel
- Designed to cover up and hide the lug nut
- Convenience pack, includes 60 nut covers to dress up your entire truck

**10769CB** 60 Pcs. / Color Box

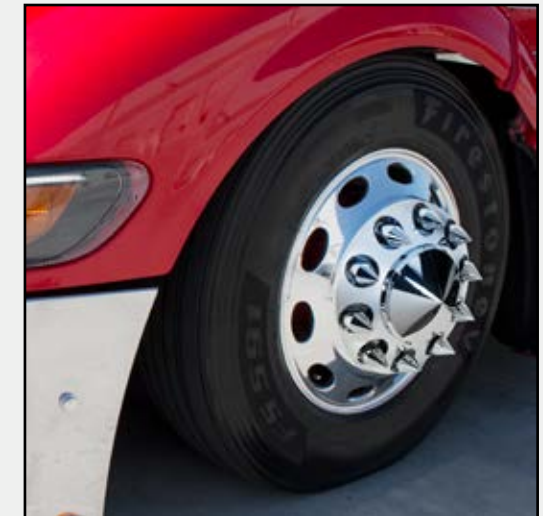

### Matte Black Front Axle Cover w/ 33mm Thread-on Nut Cover

- Fits most 20", 22 1/2" and 24 1/2" wheels with 11 1/4" bolt circle/center applications
- Removable hub cap for easy inspection of axle
- Made from plastic that is high-impact, light-weight, and corrosion resistant
- Each set includes 1 cover, 1 cap, and 10 nut covers
- Replacement parts: black 33mm thread-on nut cover (item # 10552B)
- A minimum of 3 threads extending through the top of each nut is required for installation

**10334** Dome - 1 Pc. / Color Box

**10339** Pointed - 1 Pc. / Color Box



**60 PCS. CONVENIENCE PACK**



**1-1/2" X 2-1/4" Chrome Plastic Standard Nut Cover - Push-On (60/Pack)**

- High quality chrome finish for durability and shine
- Fits over standard 1-1/2" lug nuts on stud piloted wheel
- Designed to cover up and hide the lug nut
- Convenience pack, includes 60 nut covers to dress up your entire truck

**10057CB** 60 Pcs. / Color Box

**60 PCS. CONVENIENCE PACK**



**33mm x 4-1/4" Black Tall Cylinder Nut Cover - Thread-On (60/Pack)**

- High quality injection molded plastic in matte black finish
- Fits over standard 33mm lug nuts on hub piloted wheel
- Designed to cover up and hide the lug nut flange washer
- Convenience pack, includes 60 nut covers to dress up your entire truck

**10190CB** 60 Pcs. / Color Box



**Driver Assist Grab Bar Leather Cover**

- Comfortable padded grip for driver assist bar
- Engineered leather - long lasting look & feel of leather
- Easy Installation with high strength zipper

|              |                                      |                             |
|--------------|--------------------------------------|-----------------------------|
| <b>70412</b> | 17" for PB 388, 389                  | <b>Black</b> - 1 Pc. / Bulk |
| <b>70413</b> | 17" for PB 388, 389                  | <b>Brown</b> - 1 Pc. / Bulk |
| <b>70414</b> | 20.5" for Cascadia Classic 2008-2017 | <b>Black</b> - 1 Pc. / Bulk |
| <b>70415</b> | 20.5" for Cascadia Classic 2008-2017 | <b>Brown</b> - 1 Pc. / Bulk |

|              |   |                             |
|--------------|---|-----------------------------|
| <b>70416</b> | 24" for KW T680/Cascadia 2018+                        | <b>Black</b> - 1 Pc. / Bulk |
| <b>70417</b> | 24" for KW T680/Cascadia 2018+                        | <b>Brown</b> - 1 Pc. / Bulk |
| <b>70418</b> | 27.5" for Volvo Gen 2 VN 2004-18                      | <b>Black</b> - 1 Pc. / Bulk |
| <b>70419</b> | 27.5" for Volvo Gen 2 VN 2004-18                      | <b>Brown</b> - 1 Pc. / Bulk |
| <b>70420</b> | 31.5" for PB 387/Cascadia 2018+                       | <b>Black</b> - 1 Pc. / Bulk |
| <b>70421</b> | 31.5" for PB 387/Cascadia 2018+                       | <b>Brown</b> - 1 Pc. / Bulk |
| <b>70422</b> | 35" for KW T680/Volvo Gen 2 Vn 2004-18/Cascadia 2018+ | <b>Black</b> - 1 Pc. / Bulk |
| <b>70423</b> | 35" for KW T680/Volvo Gen 2 Vn 2004-18/Cascadia 2018+ | <b>Brown</b> - 1 Pc. / Bulk |



**COMPETITION SERIES**

**Stainless Rear Center Panel w/ Four 7 LED 4" Light & Six 7 LED 2" Light & Flat Bezels - Red LED/Clear Lens - Competition Series**

- Polished 430 stainless steel center panel w/ enclosed steel back panel, item number 21493
- Four 7 red LED w/ clear lens S/T/T light, item # 39118B, Six 9 LED 2" marker LED light, Item # 38363B

**35083** 1 Pcs. / Color Box



**COMPETITION SERIES**

**2 1/2" Bolt Pattern Spring Loaded Rear Light Bar w/ Six 7 LED 4" Light & Flat Bezels - RED LED/Clear Lens Competition Series**

- Spring loaded rear light bar with six 4" LED lights
- Polished 430 stainless steel three 4" light cutouts, item number 22301

**61763** 1 Pcs. / Color Box

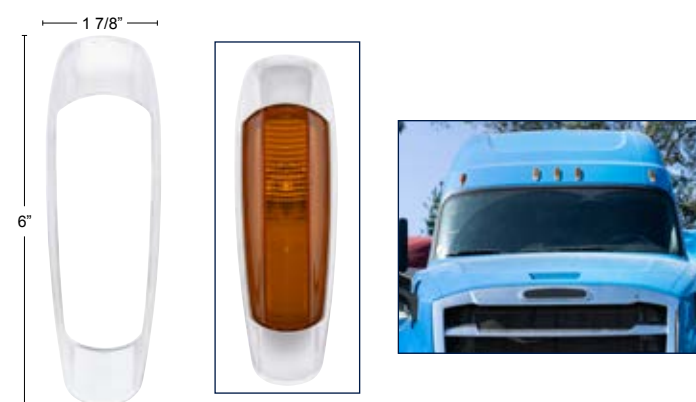

**Chrome Cab Light Bezel for 2018+ Freightliner Cascadia**

- Easy installation with double sided tape
- Beautifully chrome plated, corrosion resistant plastic
- Show winning shine, dress up your truck

**42443** 1 Pc. / Card



**COMPETITION SERIES**

**Stainless Rear Center Panel w/ Four 7 LED 4" Light - RED LED/CLEAR LENS - Competition Series**

- Polished 430 stainless steel center panel w/ enclosed steel back panel, item # 21475
- Four 7 red LED w/ clear lens S/T/T light, item # 39118B
- Includes LED license light, chrome license frame, bullet fastener, and rubber grommet

**35084** 1 Pcs. / Color Box



**GloLight.**



**Stop/Turn/Tail & Marker Lights Display**

- United pacific stainless steel light display, features in GLO and MIRAGE lights
- Display approximate size: 46" x 15 1/2"
- Display includes item # 36922, 36607, 36980, 36976, 37016, 37035, 36924, 36861, 37080, 38946, 39398, 39592, 36524, 38364, 36656, 39924, 36652, 37090

**99153** 1 Pcs. / Box

**All Metal Heavy Duty**



**Heavy Duty Aluminum Glad Hand Lock**

- Constructed from high strength aluminum casting
- Increases safety during loading and unloading
- 2 keys included, all 90618 & 90619 are keyed alike for convenient master key applications

|              |                              |
|--------------|------------------------------|
| <b>90618</b> | <b>Chrome</b> - 1 Pc. / Card |
| <b>90619</b> | <b>Red</b> - 1 Pc. / Card    |



### Chrome 4-Switch Dash Panel Trim For 2018+ Freightliner Cascadia

- Quality molded plastic with beautiful long lasting chrome plating
- Easy installation with double sided tape
- Dress up your truck with show winning shine
- Chrome switch covers available separately, item # 42425

**42444** 1 Pc. / Card

### Chrome Switch Cover For 2018+ Freightliner Cascadia (2/Pack)

- Quality molded plastic with beautiful long lasting chrome plating
- Easy installation with double sided tape
- Chrome switch panel trim available separately, item #42444 & 42438

**42425** 2 Pcs. / Card

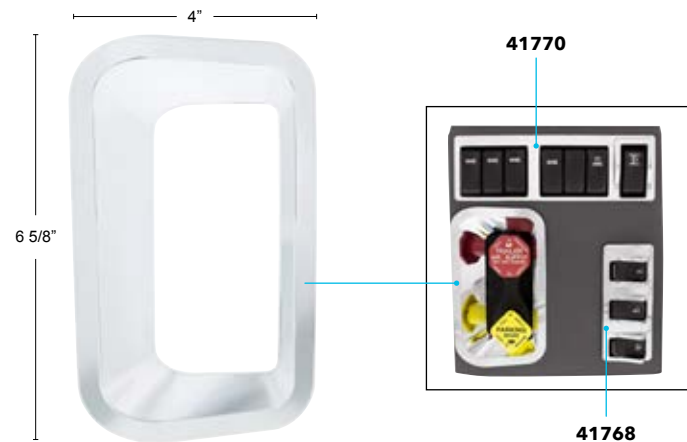

### Chrome Air Valve Trim for 2010+ Peterbilt

- Fits Peterbilt 579 and various 2010+ Peterbilt models
- Easy installation with included double sided tape

**41771** 1 Pc. / Card



### 4-1/4" Stress Ballz Novelty Keychain - Blue

- Stress relieving novelty keychain made of squishy foam
- Great for relieving stress and anxiety on the go
- 1-1/4" stainless split key ring included

**78027** 1 Pc. / Card



### United Pacific Store Slatwall Display

- Perfect way to display United Pacific products

**99142** 1 Pc. / Box



### United Pacific Bar Stool

- United Pacific Bar Stool

**99041** 1 Pc. / Bulk

# NEW ITEMS

November 2019

## 18" Steering Wheels with Matching Horn Bezel and Chrome Horn Button



### 18" Steering Wheel with Matching Bezel

- High quality wood rims available in polished woodgrain finish, or vibrant colors with matching horn bezel and chrome horn button
- 18" diameter with comfortable finger grips on back edge of rim
- Fits all commercial 3 bolt hubs, sold separately

**88309** **Flame** - 1 Pc. / Color Box  
**88310** **4 Spoke** - 1 Pc. / Color Box  
**88311** **Boss** - 1 Pc. / Color Box

**88312** **Lady** - 1 Pc. / Color Box  
**88313** **Blue 4 Spoke** - 1 Pc. / Color Box  
**88314** **Red 4 Spoke** - 1 Pc. / Color Box  
**88315** **Blue Boss** - 1 Pc. / Color Box  
**88317** **White Skull** - 1 Pc. / Color Box  
**88318** **Blue Skull** - 1 Pc. / Color Box  
**88319** **Red Skull** - 1 Pc. / Color Box

### 18" Vibrant Color 4 Spoke Steering Wheel - Liquid Silver

- Premium automotive paint in vibrant candy colors, bold effects and dazzling color
- High quality steel with chrome plating
- Steering wheel only, commercial 3-bolt hub and horn button/bezel assembly available separately
- Mix and match with U.P. designer horn bezels, gearshift knobs, shifter shaft extensions and air valve knobs, available separately

**88281** 1 Pc. / Color Box



**60** 60 PCS. CONVENIENCE PACK



**1-1/2" x 2-3/4" Chrome Plastic Slotted Bullet Nut Cover - Push-On (60/Pack)**

- Fits over standard 1-1/2" lug nuts on stud piloted wheel
- Designed to cover up and hide the lug nut
- Convenience pack, includes 60 nut covers to dress up your entire truck

**10045CB** 60 Pcs. / Color Box

**60** 60 PCS. CONVENIENCE PACK



**1-1/2" x 2-3/4" Chrome Plastic Tall Nut Cover - Push-On (60/Pack)**

- Fits over standard 1-1/2" lug nuts on stud piloted wheel
- Designed to cover up and hide the lug nut
- Convenience pack, includes 60 nut covers to dress up your entire truck

**10084CB** 60 Pcs. / Color Box

**60** 60 PCS. CONVENIENCE PACK



**1-1/2" x 2-3/4" Chrome Plastic Bullet Nut Cover - Push-On (60/Pack)**

- Fits over standard 1-1/2" lug nuts on stud piloted wheel
- Designed to cover up and hide the lug nut
- Convenience pack, includes 60 nut covers to dress up your entire truck

**10047CB** 60 Pcs. / Color Box

**60** 60 PCS. CONVENIENCE PACK



**33mm x 4-1/2" Chrome Plastic X Spike Nut Cover - Thread-On (60/Pack)**

- Fits over standard 33mm lug nuts on hub piloted wheel
- Designed to cover up and hide the lug nut flange washer
- Convenience pack, includes 60 nut covers to dress up your entire truck

**10780CB** 60 Pcs. / Color Box

**60** 60 PCS. CONVENIENCE PACK



**33mm x 4-3/4" Black Spike Nut Cover w/ Flange - Thread-On (60/Pack)**

- Fits over standard 33mm lug nuts on hub piloted wheel
- Designed to cover up and hide the lug nut flange washer
- Convenience pack, includes 60 nut covers to dress up your entire truck

**10548CB** 60 Pcs. / Color Box



**Matte Black Rear Axle Cover w/ 33mm Thread-on Nut Cover**

- Fits most 20", 22 1/2" and 24 1/2" wheels with 11 1/4" bolt circle/center applications
- Removable hub cap for easy inspection of axle
- Each set includes 1 cover, 1 cap, and 10 nut covers
- Replacement parts: black 33mm thread-on nut cover (item # 10552B)

**10335** **Dome** - 1 Pc. / Color Box

**10340** **Pointed** - 1 Pc. / Color Box



**Matte Black Pointed Front Axle Cover w/ 33mm Spike Thread-on Nut Cover**

- Fits most 20", 22-1/2" and 24-1/2" wheels with 11-1/4" bolt circle/center applications
- Removable hub cap for easy inspection of axle
- Each set includes 1 cover, 1 cap, and 10 nut covers
- Replacement parts: black 33mm spike thread-on nut cover (item # 10548B)

**10336** 1 Pc. / Color Box



**Cab Splash Guard for 2018+ Freightliner Cascadia**

- High quality plastic injection molded with durable fiber reinforced polypropylene plastic
- Sold individually, please specify driver or passenger side
- OEM part number: 22-73807-000 (driver) / 22-73807-001 (passenger)

**21006** **Driver** - 1 Pc. / Box

**21007** **Passenger** - 1 Pc. / Box



**Chrome Fuel Tank Trim For 2008-2017 Freightliner Cascadia**

- Fits 2008-2017 Freightliner Cascadia classic trucks
- Easy installation, mounting clips included
- Direct replacement of OEM fuel tank trim: 42418 fits OEM part #A22-65004-000 / 42419 fits OEM part #A22-65004-001
- Dress up your truck

**42418** **Driver** - 1 Pc. / Card

**42419** **Passenger** - 1 Pc. / Card

**Dual Color High Power 12V H11 LED Bulbs - White/Yellow (2 Pack)**

- Special engineered 240 degree wide angle dual color LED design
- Primary 6500K white color temp. LED with 1400 lumen output
- Secondary 3000K bright yellow color temp. LED with 1150 lumen output
- Features highly efficient rear heatsink design to help dissipate heat and prolong bulb life
- Small form factor in-line LED driver ballast
- Direct plug-n-play to H11 housing and socket
- Includes quality high temp rubber seal on bulb body
- White LED comes on by default. To switch over to yellow, simply turn off and on within 10 seconds
- Yellow LED is designated for fog light use only, not to be use as normal driving light



**36468** 2 Pcs. / Color Box

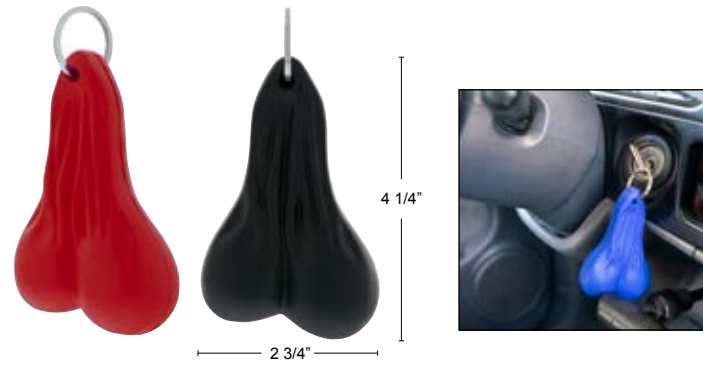

**4-1/4" Stress Ballz Novelty Keychain**

- Stress relieving novelty keychain made of squishy foam
- Great for relieving stress and anxiety on the go
- 1-1/4" stainless split key ring included

|              |                                   |
|--------------|-----------------------------------|
| <b>78028</b> | <b>Black</b> - 1 Pc. / Card (NEW) |
| <b>78029</b> | <b>Red</b> - 1 Pc. / Card (NEW)   |
| <b>78027</b> | <b>Blue</b> - 1 Pc. / Card        |



**Display For 4" X 6" Lights**

- Attractive counter top display with interactive push buttons
- Ready to use, requires 110V outlet

|              |                                  |
|--------------|----------------------------------|
| <b>99145</b> | <b>31089+31397</b> - 1 Pc. / Box |
| <b>99146</b> | <b>31275+31238</b> - 1 Pc. / Box |
| <b>99147</b> | <b>34123+34124</b> - 1 Pc. / Box |



**United Pacific Modular Headlight Display**

- Steel display base with attractive black powder coated finish
- Includes 12V power supply unit & wall plug
- Completely assembled and wired
- Display approximate size: 27" L X 15 1/2" W X 17" H

|              |   |
|--------------|---|
| <b>99162</b> | <b>31082 Display for PB 386/387</b> - 1 Pc. / Box             |
| <b>99163</b> | <b>31090 Display for 1996-2018 /FL Columbia</b> - 1 Pc. / Box |
| <b>99164</b> | <b>31144 Display for PB 388/389</b> - 1 Pc. / Box             |



**Coiled Nylon-12 Air Hose**

- Replacement fifth wheel slide air cylinder hose
- Extends up to 10 feet
- Includes male 1/4" NPT on each end
- Meets DOT and SAE J844 Type-A specifications

|              |              |
|--------------|--------------|
| <b>89996</b> | 1 Pc. / Card |
|--------------|--------------|



**3/8" x 50' Polypropylene Rope**

- 3/8" diameter x 50' long
- 92040 - Breaking strength 557 lbs; working load 186 lbs
- 92041 - Breaking strength 810 lbs; working load 270 lbs

|              |   |
|--------------|---|
| <b>92040</b> | <b>557 lbs Breaking Strength</b> - 1 Pc. / Card |
| <b>92041</b> | <b>810 lbs Breaking Strength</b> - 1 Pc. / Card |

**NEW ITEMS**

**Peterbilt Headlight**

**100% LED**

**DOT**

**Deluxe Series**  
Made in Taiwan

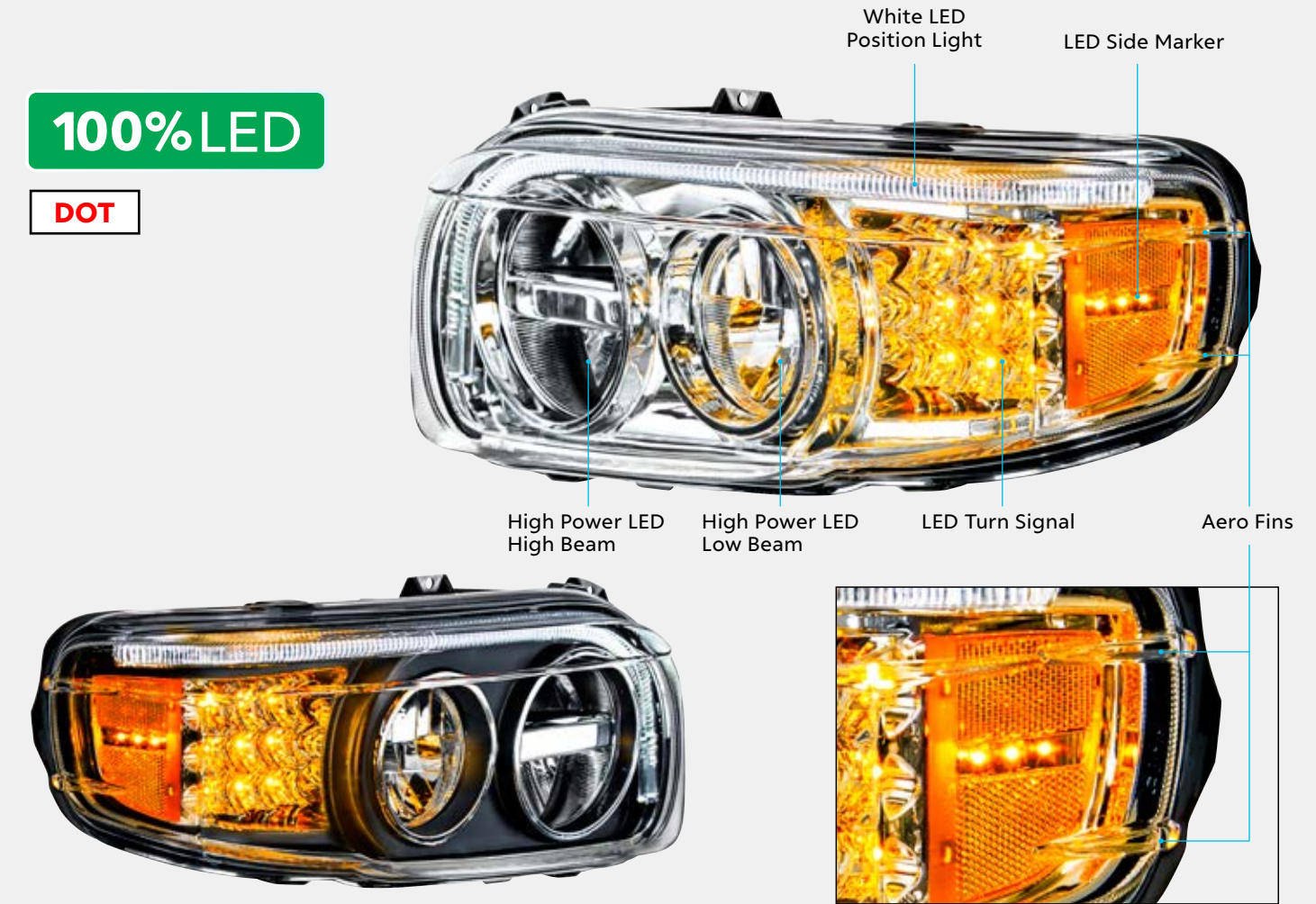

**LED Headlight with LED Turn Signal & LED Position Light Bar For 2008+ Peterbilt 388/389**

- Bold and unique headlight design. Patent pending design
- Headlight assembly for Peterbilt 388/389 trucks
- 100% all LED high & low beam headlight with white position light & LED turn signal
- Easy connection, plugs into existing wiring harness
- DOT/SAE, FMVSS 571.108
- Sold individually, please specify driver or passenger side
- Low beam application: 1,000 lumens, 2.3 amps / 28 watt
- High beam application: 2,000 lumens, 4.6 amps / 56 watt



| Technical Specification |                       |
|-------------------------|-----------------------|
| Low Beam Application    | High Beam Application |
| 1000 Lumens             | 2000 Lumens           |
| 6300K                   | 6300K                 |
| 2.3 amps                | 4.6 amps              |

|              |          |                                      |
|--------------|----------|--------------------------------------|
| <b>35794</b> | Chrome   | <b>Driver</b> - 1 Pc. / Color Box    |
| <b>35795</b> | Chrome   | <b>Passenger</b> - 1 Pc. / Color Box |
| <b>35796</b> | Blackout | <b>Driver</b> - 1 Pc. / Color Box    |
| <b>35797</b> | Blackout | <b>Passenger</b> - 1 Pc. / Color Box |



**100%LED**

**DOT**



**High Power 10 LED Headlight w/ LED Position Light & LED Turn Signal For 2008+ Peterbilt 388/389**

- Bold and unique headlight design. Patent pending design
- Headlight assembly for Peterbilt 388/389 trucks
- Dual color LED position light bar changes from white to amber when turn signal activated
- Patent pending unique lens design
- Easy connection, plugs into Easy connection, plugs into existing wiring harness
- DOT/SAE headlight approved
- Sold individually, please specify driver or passenger side

| Technical Specification     |                              |
|-----------------------------|------------------------------|
| <b>Low Beam Application</b> | <b>High Beam Application</b> |
| 2500 Lumens                 | 1700 Lumens                  |
| 5500K                       | 5500K                        |
| 1.13 amps                   | 1.42 amps                    |

|              |          |                                      |
|--------------|----------|--------------------------------------|
| <b>35784</b> | Chrome   | <b>Driver</b> - 1 Pc. / Color Box    |
| <b>35785</b> | Chrome   | <b>Passenger</b> - 1 Pc. / Color Box |
| <b>35786</b> | Blackout | <b>Driver</b> - 1 Pc. / Color Box    |
| <b>35787</b> | Blackout | <b>Passenger</b> - 1 Pc. / Color Box |



**33mm x 3-3/4 inch Chrome Plastic Dome Nut Cover - Thread-On (60/Pack)**

- Fits over standard 33mm lug nuts on hub piloted wheel
- Designed to cover up and hide the lug nut flange washer
- Convenience pack, includes 60 nut covers to dress up your entire truck

**10563CB** 60 Pcs. / Color Box



**33mm x 4-1/8 inch Chrome Plastic Spike Nut Cover - Push-On (60/Pack)**

- Fits over standard 33mm lug nuts on hub piloted wheel
- Designed to cover up and hide the lug nut flange washer
- Convenience pack, includes 60 nut covers to dress up your entire truck

**10566CB** 60 Pcs. / Color Box

**COMPETITION SERIES**  
Made in China



**Matte Black Dome Rear Axle Cover w/ 33mm Spike Thread-on Nut Cover**

- Fits most 20", 22-1/2" and 24-1/2" wheels with 11-1/4" bolt circle/center applications
- Removable hub cap for easy inspection of axle
- Each set includes 1 cover, 1 cap, and 10 nut covers
- Replacement parts: black 33mm spike thread-on nut cover (item # 10548B)

**10342** 1 Pc. / Color Box



**Chrome Dash Storage Pocket Trim for 2018+ Freightliner Cascadia**

- High quality molded plastic with triple chrome plating
- Easy installation with included double sided tape
- Fits OE number 22-73938-000

**42437** 1 Pc. / Card



**Chrome Hazard Switch Panel Trim For 2018+ Freightliner Cascadia**

- Quality molded plastic with beautiful long lasting chrome plating
- Easy installation with double sided tape
- Complete the look with chrome switch cover, item #42425 / Chrome dash switch trim, item #42444

**42438** 1 Pc. / Card

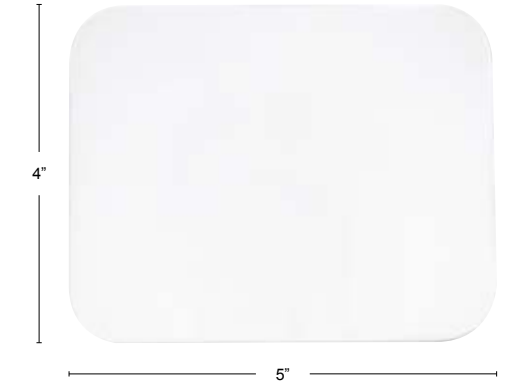

**Stainless Steel 4" x 5" Permit Sticker Plate With Adhesive**

- High quality 304 stainless steel
- Universal permit panel
- Sold individually
- Adhesive application

**21904** 1 Pc. / Card

**21904B** 1 Pc. / Bulk

**NEW PACKAGING**



**IP-67 WATERPROOF**  
3,700 Lumens High Function  
1,800 Lumens Low Function

**5" x 7" 9 LED Rectangular Light with 6 White LED Light Bar**

- Rugged die cast aluminum housing provides maximum protection from vibration and the elements
- High beam: 3700 lumens, 6500K color temp, and Low beam: 1800 lumens, 6500K color temp
- White LED position light: 180 lumens
- IP67 Weather Resistant Rating
- Operation voltage: 12VDC, 2.6amps High beam, 2.6amps low beam

**34122** 1 Pc. / Color Box



**Heavy Duty Steering Wheel Spinner**

- Fits 1-1/8" to 1-5/16" diameter steering wheel grips
- Heavy duty chrome die cast clamp
- Classic design intended to reduce effort and fatigue
- Includes 2 rubber spacers to accommodate different grip diameters
- Matching color steering wheel bezels, shift knobs, and air valve knobs available
- Not recommended for padded steering wheels

|              |                                       |
|--------------|---------------------------------------|
| <b>70362</b> | <b>Indigo Blue</b> - 1 Pc. / Card     |
| <b>70363</b> | <b>Emerald Green</b> - 1 Pc. / Card   |
| <b>70364</b> | <b>Cadmium Orange</b> - 1 Pc. / Card  |
| <b>70365</b> | <b>Candy Red</b> - 1 Pc. / Card       |
| <b>70366</b> | <b>Liquid Silver</b> - 1 Pc. / Card   |
| <b>70367</b> | <b>Pearl White</b> - 1 Pc. / Card     |
| <b>70368</b> | <b>Electric Yellow</b> - 1 Pc. / Card |



**High Power 8 LED 1157 Bulb**

- 8 High Power SMD LED's, 80 lumens / 250 lumens
- Replaces most #1157 and #P21/5W applications
- 12 Volt, double contact with off-set pins

|              |                                   |
|--------------|-----------------------------------|
| <b>36443</b> | <b>White</b> - 2 Pcs. / Color Box |
| <b>36444</b> | <b>Red</b> - 2 Pcs. / Color Box   |
| <b>36445</b> | <b>Amber</b> - 2 Pcs. / Color Box |



**United Pacific LED Bulb Display**

- Display approximate size: 16-3/4" X 6-1/4"
- Display includes item # 36543/36550/36920/36931/36932/36934/ 36935/36918/38897/36443

|              |             |
|--------------|-------------|
| <b>99159</b> | 1 Pc. / Box |
|--------------|-------------|



**United Pacific, Long Beach Tee**

- Great looking fatigue green color

|                 |                               |
|-----------------|-------------------------------|
| <b>99180M</b>   | <b>Medium</b> - 1 Pc. / Bulk  |
| <b>99180L</b>   | <b>Large</b> - 1 Pc. / Bulk   |
| <b>99180XL</b>  | <b>XLarge</b> - 1 Pc. / Bulk  |
| <b>99180XXL</b> | <b>XXLarge</b> - 1 Pc. / Bulk |



**United Pacific 7" LED Headlight Display**

- Attractive counter top display with interactive push buttons
- Ready to use, requires 110V outlet

|              |  |
|--------------|--|
| <b>99187</b> | <b>Display for 31459</b> - 1 Pc. / Box |
| <b>99188</b> | <b>Display for 31496</b> - 1 Pc. / Box |
| <b>99189</b> | <b>Display for 31513</b> - 1 Pc. / Box |
| <b>99190</b> | <b>Display for 31084</b> - 1 Pc. / Box |

**New Accounts**

Initial minimum buy-in is \$2,000 (or to be determined by United Pacific Industries, UPI hereafter). All initial orders must be prepaid in advance by Cashier's Check or VISA/MC. All new/potential accounts must complete a UPI "New Customer Info/Credit Form" and follow the Dealer Qualification Instructions. Upon completion of the credit application, approved accounts will be assigned payment terms of NET 30 Days (from invoice date). Accounts denied a credit line will be required to prepay in advance by Cashier's Check or VISA/MC.

**Payment Terms:**

**Term Accounts**

Accounts with NET 30 Days terms are required to submit payment within the 30 days from the date of invoice. Acceptable forms of payment include checks, ACH (Automated Clearing House), or wire transfer.

A service charge of 1.5% per month will be imposed on invoices not paid within the 30 day term. Delinquent accounts will be required to pay Cash-In- Advance (CIA). Checks will be accepted but orders will not be released until the check is cleared by the bank. Past due invoices will delay current orders. Please check with UPI on your account status when placing an order.

**Credit Cards**

Accounts denied credit terms may pay by Visa or MasterCard. Credit card will be charged upon shipment. Credit card payments will not be accepted once an order has been shipped. UPI does not accept American Express or Discover card.

**COD**

A \$9.00 fee will be accessed per COD box for all FedEx/UPS COD shipments. Truck COD shipment fees are to be determined later by trucking company.

**Returned Checks:**

A \$30 NSF (Non Sufficient Fund) fee will be assessed on each incidence a check is returned to UPI.

**ORDERING GUIDELINES**

Placing Orders: New orders may be placed by any of the following methods

1. Fax: **888.986.5988**
2. E-mail: **antique@upauto.com**
3. Telephone: In order to minimize errors, customers are encouraged to submit their orders by fax or email. Telephone orders should be limited to smaller orders such as add-ons to orders already submitted and/or fill-ins occurring between larger restocking orders.

**Changes to Orders:**

Whenever possible, revisions to orders - additions or deletions of items - should also be submitted via fax or email to reduce the possibility of errors.

Additions/Deletion of items will only be accepted within 48 hours after the initial order date and/or before 12:00PM on the date of the shipment. Additions of items placed after the 48 hours time period will be considered a new order and adhere to a new order freight prepaid policy. Deletions of item cannot happen after the 48 hours time period and/or after 12:00PM on the date of the shipment. Please note additions and/or deletions of items will delay the shipment date.

**Canceling Orders:**

Cancellation of orders must be submitted via fax or email within 24 hours of the order date. If the order has already shipped it will be the customers responsibility to return the order at the customers own expense. A restocking fee may apply, please see "Return" policy for further detail.

**Backorders:**

Customers have the option of having their backorders shipped or canceled. UPI will notify customer as to availability of backorders and will be able to ship any backorder items customer still needs as part of their next stock order. UPI reserves the right to cancel backorders that are 6 months or older from the initial invoice date.

**Minimum Order:**

A minimum order of \$50.00 is required. Orders below \$50.00 will be assessed a minimum order fee of \$10.00.

**Packaging:**

A 10% service charge will be added to orders with special packaging or UPC barcoding requirements.

**Lead Times:**

Standard lead time for all United Pacific orders is 1-3 business days from the receipt of the purchase order. Larger orders may require a lead time of up to 5 business days. Transit time of 3-5 business days must be considered when placing orders. UPI cannot be responsible for delays in shipment after an order leaves our warehouse. UPI will work to resolve delays with freight forwarding firms, however, delays do arise from time to time due to weather and unforeseen circumstances beyond UPI's control. Express order are exempted; please view Freight/Shipping Policy for further detail.

**Order Confirmation:**

United Pacific will acknowledge receipt of orders by email/fax/ telephone within 1 business day of receipt. If confirmation is not received, please contact UPI to ensure your order was received.

**FREIGHT**

**Prepaid Freight:**

Stock orders between \$50 and \$999.99 (US Lower 48 States), **\$50 and \$2499.99 (Alaska and Hawaii)**, **\$50 and \$1499.99 (Canada)**, [all price net US\$], will be shipped FOB Long Beach, California. Stock orders of \$1,000 (US Lower 48 States), **\$2500 (Alaska and Hawaii)**, **\$1500 (Canada)**, [based on UPI current pricing], or more will be shipped Freight Prepaid Ground to a single location only. (See exception for Oversize Items\*). Express Air orders, Special Net Pricing orders, and Special Quote Pricing orders are excluded. United Pacific reserves the right to select the carrier of our choice. Customers may select the carrier of their choice at their own expense, negotiated rates and insurance. If customers elect to choose their own freight carrier, orders will be shipped via FREIGHT COLLECT.

**Oversize Item Freight Policy** - Applies to 1932 Ford car & truck body shell assemblies, 1932 Ford car & truck body parts such as floor assembly, roof, door, fender, quarter panel, grille, bulk rail gutter, bulk roof tack strip, chassis & frame, wheels & tire, and any exceptionally large or heavy item.

1. Freight will be prepaid by United Pacific if the total order of all items exceeds \$4,000 (US Lower 48 States) or **\$5000 (Hawaii, Alaska and Canada)**, [all price net US\$]. There will not be additional charges for these items included on the order.
2. Freight will be prepaid by United Pacific if a customer orders a total of \$2,500 (US Lower 48 States) or **\$3500 (Hawaii, Alaska and Canada)**, [all price net US\$], of PB 379 fenders, 60" or longer exhaust, and/or 18"+ Longer Saddle Boxes only. If the order is below \$2,500 (US Lower 48 States) or **\$3500 (Hawaii, Alaska and Canada)**, United Pacific will add freight charges to the order for the oversize items.

**Will Call Orders:**

Will Call orders can be picked up 2 - 4 hours after placing the order. Customers should always call ahead to confirm when order will be ready to pick up.

## SHIPPING POLICY / CLAIMS

IMPORTANT: PLEASE REVIEW CAREFULLY

### SHIPPING POLICY

#### International Shipments:

Shipments to locations outside the continental United States will be shipped to the customer's shipping agent or broker within the continental United States in accordance with the US freight policy. International customers will be responsible for the duties and taxes of their respective country.

#### Express Orders:

All express orders, such as Next Day, Second Day, 3 Day Service & Will Call, must be faxed/mailed. Order confirmation will be faxed to the customer for final approval. If confirmation is not received, please contact UPI to ensure your order was received. Customers are required to sign off on express orders and fax confirmation back to UPI. Cut off for express order is 12:00PM. Express orders received after 12:00PM may or may not ship the same day. Please call UPI to confirm projected shipping date or will call time.

Due to the high cost of express shipments, customer may request UPI to call to confirm freight charges. If customer does not request confirmation, UPI will ship the express order.

#### Drop Shipments:

All drop shipment orders will be assessed a 5% processing fee. Drop shipment processing fee will be automatically added to the invoice without notice. All drop shipment orders must be faxed in. No freight allowance or prepaid freight will be permitted for any drop shipments, thus, all drop ship orders, regardless of order size, are FOB Long Beach, CA.

### CLAIMS

#### General Policy:

All claims (Shortage, Mis-Shipped, Damage, Overage, Customer Error & Billing Error) must be submitted to UPI within 3 business days of the receipt of shipment. Claims submitted beyond 3 business days of the receipt of shipment will be voided by UPI.

On all shipments, the person who signs and receives the shipment is responsible for noting on the Bill of Lading, in writing, whether any boxes arrived damaged or shorted. Failure to do so will void all claim rights between all parties. UPI will have no recourse against the trucking company if customer does not note any damages or shortages on the Bill of Lading.

The customers receiving department must count and sign for the exact number of boxes received. Failure to follow the above instructions will void all claim rights between all parties.

#### Shortages / Mis-Ships / Damages

While UPI strives to fill every order with 100% accuracy, on occasion an item may get shipped in error or get damaged during shipping. In the event this occurs, please follow the process below. Note: This type of claim must be reported to UPI within three (3) business days of receiving the order.

1. Contact the United Pacific office to initiate the claim. To make it easy for you we have two acceptable methods for requesting the claim:

- By e-mail : [returns@upauto.com](mailto:returns@upauto.com)
- By fax : **888.986.5988**

**\* Note: To ensure you receive a timely credit, we cannot accept claim requests by phone.**

2. You will be required to provide the following information:

- Your business name
- Contact name and telephone number (in case we have questions)
- Date the order was received
- A copy of the Packing List / Invoice noting the item number and quantity that was shipped in error or damaged during shipping.
- Special instructions you have for us.

3. UPI will send a return label so you can ship the items back.

4. Once we receive the miss-shipped/damaged item(s) a credit will be issued to your account on the next billing cycle.

5. Shortages will be credit to the Customers' account, unless customer would like the shortages replaced.

#### Overages:

UPI strives to provide our customers with the best customer service and products, in turn we would greatly appreciate any help from customer in notifying UPI of any shipping overages. Customers will be offered the option of retaining the merchandise or returning the merchandise to UPI at UPI's expense. If the items are to be returned, an RMA number and return shipping label will be provided.

#### Customer Errors:

Any item or quantity ordered in error by the customer may be returned by contacting UPI for a RMA No.

1. To make it easy for you we have two acceptable methods for requesting the RMA:

- By e-mail: [returns@upauto.com](mailto:returns@upauto.com)
- By fax: **888.986.5988**

**\* Note: To ensure you receive a timely RMA credit, we cannot accept RMA requests by phone.**

2. You will be required to provide the following information.

- \* Your business name
- \* Contact name and telephone number (in case we have questions)
- \* A list of the items number and quantity ordered in error
- \* Special instructions you have for us

3. UPI will review the request to ensure the products are within the return period.

4. Once we have validated the request, United Pacific will issue an RMA number to the customer. In issuing the RMA approval, the following conditions will apply :

- Returned items are subject to a 20% re-stocking fee.
- Return shipping costs are the responsibility of the customer.
- Items must not have any retail/price sticker on exterior packaging or they will be returned to the customer at customer's expense and no credit given.
- Items must be in good condition with original packaging intact or they will be returned to the customer at customer's expense and no credit given.
- Allow up to 30 days for the credit to be issued from the time the returned items are received.

#### Billing Errors:

Billing errors should be reported to UPI within 3 business days of invoice receipt. Customers are asked to provide the invoice number, part number, and quantities in question. Once verified, UPI will issue a credit or an invoice for the difference in billing error.

## WARRANTY POLICY / RETURNS

IMPORTANT: PLEASE REVIEW CAREFULLY

### WARRANTY POLICY

#### General Policy:

UPI offers a NO HASSLE WARRANTY RETURN policy to all our customers. Warranty claims can only be submitted through an authorized UPI Distributor. UPI warranty is not transferable and applies to the original installation and purchase only. In no event shall UPI be liable for incidental or consequential damages, nor shall UPI be liable for any claims or damages arising out of or connected with the UPI warranty exceed the purchase price of the products. There are no warranties, expressed or implied (including any warranty of merchantability or fitness) that extend beyond this warranty. The warranty does not apply to costs associated with the loss of use of the product, loss of time, inconvenience, commercial loss, incidental or consequential damages. UPI reserves the right to alter the designs of products without assuming any obligation to modify previously manufactured products and will only replace warranted products with redesigned products.

Warranty does not apply to merchandise that has been drilled, cut, welded, modified in any way or installed contrary to normal installation and usage. In addition, UPI cannot be held liable for damages caused by road hazards, accidents, misuse, neglect, abuse or corrosive environments including acid washes and highway snow/ice chemicals which can cause discoloration and corrosion in aluminum, chrome, stainless steel and light products. UPI reserves the right to credit returned merchandise at the initial purchase price or at the current selling price, which price ever is lower.

#### Aluminum / Chrome / Stainless Steel Products:

All aluminum, chrome, and stainless steel products carry a limited 6 month warranty (from invoice date) against defects in material or workmanship.

#### Lighting Products:

##### Incandescent

All incandescent lighting products carry a limited 12 month warranty (from invoice date) against defects in material or workmanship. The limited 12 month warranty does not apply to several applications, such as, buses, construction equipment, and off road vehicles.

##### LED

All LED lighting products carry a specific Limited Warranty (from invoice date) against defects in material or workmanship.

- LED with vehicle specific application is limited lifetime warranty to an original purchaser with receipt. Examples of lifetime warranty product: CTL5720LED CTL5720LED for 1957 Chevy, FTL3201LED-L for 1932 Ford.
- LED Marker, 2", 2-1/2", 4", 7", Oval & Square Lights - Varies from 2 years to 10 years to Limited Lifetime, depending on specific item. The housing, bezel or mounting base on any light made from Chrome/Stainless carries a 6 month limited warranty.
- LED Cab Lights and Kits, Double/Single Stud Turn Signal and PB/KW/FL/WL or non-make Turn Signals and any/all Strip Lights - Varies from 2 years to 10 years to Limited Lifetime, depending on specific item. The housing, bezel or mounting base on any light made from Chrome/Stainless carries a 6 month limited warranty.
- LED Beacon, Driving, Headlights, Work & Warning Lights - Varies from 6 months to 3 years. The housing, bezel or mounting base on any light made from Chrome/Stainless carries a 6 month limited warranty.
- All LED Accessory Lights (Honda, Stainless Steel Double/Single face Lights, Interior Lights, License Plate Lights, and any Accent Lights. The housing, bezel or mounting base on any light made from Chrome/Stainless carries a 6 month limited warranty.

### RETURNS

#### General Policy:

All returns must be authorized by UPI. All return requests must be faxed or e-mailed ([returns@upauto.com](mailto:returns@upauto.com)) A RMA number (Return Merchandise Authorization Number) will be provided. Returns not possessing a valid RMA number are subject to rejection and will be returned to sender at the customer's expense.

All customers are encouraged to use the Warranty RMA Claim Form.

#### Defective Goods / Warranty Return:

UPI offers our customers a No Hassle Warranty Return. Please follow the instructions below for requesting a RMA for defective goods:

1. If any warranty issues occur, simply contact the UPI for RMA number To make it easy for you we have two acceptable methods for requesting the RMA:

- By e-mail: [returns@upauto.com](mailto:returns@upauto.com)
- By fax: **888.986.5988**
- **Note: To ensure you receive a timely RMA credit, we cannot accept RMA requests by phone.**

2. You will be required to provide the following information:

- Your business name
- Contact name and telephone number (in case we have questions)
- A list of the defective item number and quantity with the nature/ reason of the defect
- Special instructions you have for us
- The enclosed fax form may be used for your convenience to request an RMA

3. UPI will review the request to ensure the products are within the stated warranty period.

4. Once we have validated the warranty items, a RMA confirmation, listing the items and cost will be faxed to the customer within 3 business days. UPI will process the credit to your account within 30 days.

**Note: There will be no need to return the warranty product to us. However, from time to time, UPI may require some warranty products to be shipped back so we may analyze the cause of the failure. All warranty products that are required to be shipped back will be freight prepaid by UPI.**

#### Stock Return

United Pacific Industries encourages all customers to regularly monitor the sales volume and stock level of their inventory items. As sales trends may slow the movement of specific items, our hope is that those items are featured as "close-out specials" as to minimize stock returns. We also understand that the customer, from time to time, may accumulate over-stock items and desire to return those. Therefore, we have adopted the following policy below.

#### NOTE:

- Items must have been purchased by the dealer requesting the stock return.
- Items must have been purchased within the preceding 12 months.
- Items that have been discontinued will not be considered for return.

1. Contact the United Pacific office for RMA number We have 2 acceptable methods for requesting the RMA:

- By e-mail : [returns@upauto.com](mailto:returns@upauto.com)
- By fax : **888.986.5988**

**\*Note: To ensure you receive a timely RMA credit, we cannot accept RMA requests by phone.**







**United Pacific**

UPauto.com | T 800.790.6988 | F 888.986.5988

© 2020 United Pacific Industries. All Rights Reserved.  
Products not shown to scale. Specifications subject to change without notice.

**UF1219**

2018 NEW ITEM FLYER COLLECTION  
TRUCK DIVISION



**710270060962**